

Heating Hot water Renewables

For lasting comfort in every one of your customer's homes





About Vaillant.....	4
Why choose a Vaillant product.....	6
ecoTEC & ecoFIT combi boilers.....	8
ecoTEC & ecoFIT system boilers.....	18
ecoTEC & ecoFIT open vent boilers.....	26
Terminal clearances.....	30
Flue lengths.....	31
Flue solutions.....	32
Water filters.....	35
Domestic hot water cylinders.....	37



Training	44
Service and spares support.....	45
Order numbers.....	46

Please note the information contained in this guide is for the use of competent and qualified heating engineers in the UK. We always recommend attending a training course provided by Vaillant to ensure complete knowledge of the appliance and/or accessories you are installing. The Vaillant Group does not warrant the accuracy or completeness of any of the information provided in this brochure. Should you require any clarification or further information, please speak with your Regional Business Manager or call our technical helpline. The Vaillant Group does not accept liability or responsibility resulting from the installer's failure to comply with the guides or otherwise. For more detailed information, please refer to the installation manual for each product you are using.

About Vaillant



The Vaillant Group

Vaillant UK is proud to be part of the worldwide heating and hot water corporation Vaillant Group, a family-owned business that was founded by Johann Vaillant in his workshop in Remscheid, Germany in 1874.

In 1894, Johann patented a new closed-system gas-fired bathroom boiler. Over the years, Johann's technical innovations continued and in 1924, he launched the world's first central heating boiler. Since these revolutionary inventions, Vaillant continues to drive the evolution of heating technologies, launching the first ever combi boiler in 1967, and the game changing aroTHERM plus in 2020.

Today, Vaillant is still setting the standard in the heating marketplace, developing market leading products that work seamlessly together, to provide a full systems solution. With a growing focus on developing products that use renewable energy, Vaillant became the first boiler manufacturer in the UK to launch a heat pump production line, which opened at their headquarters in Belper, 2022.

Setting the standards since 1874

Manufacturing at its finest

At Vaillant, we think ahead. By choosing our heating appliances, you choose the pioneering excellence of German design and UK manufacturing expertise that create reliable products specially designed for application in all markets.

As well as designing products to be as efficient as possible, we constantly review and update our manufacturing processes and environments.

Our UK factory continues to receive awards year after year in many categories. In addition to the many manufacturing awards we have received, we are especially proud to have been awarded the RoSPA Gold Award for world-class health and safety management systems for seven consecutive years. Since 2017, we have been accredited a gold Investors in People award.

Vaillant has very high standards in manufacturing to ensure we make outstanding products. Our products are manufactured to meet ISO 9001, 18001, 14000 and many are Quiet Mark™ approved, which means that they use innovative and efficient technology that guarantees reduced noise levels.





Why choose a Vaillant product

Vaillant manufactures one of the largest ranges of boilers in the world and has its own renewables portfolio. From simple boilers for small dwellings to complex hybrid systems for commercial premises, Vaillant has a solution for every building's requirements.

Our core business is our award winning domestic boiler range. Vaillant produces wall-hung boilers with outputs from 10kW to 64kW and has open vent, system and combination models. With a wide range of flue options and a vast catalogue of accessories, including our own range of cylinders, we are confident we have a solution for every installation. We can even offer a unique combination storage boiler that has a 21 litres per minute flow rate.

Vaillant also manufactures boilers for commercial installations. Vaillant's commercial portfolio consists of large output wall-hung and floor-standing condensing boilers with compatible cascade rigs and accessories to cater for simple and large scale projects.



Vaillant controls

We always recommend our appliances are fitted with a Vaillant control. Vaillant has a wide range of controls, and each uses eBUS protocol, our proprietary technology that ensures each element of a Vaillant system can communicate to ensure it is always working with ultimate efficiency.

Every Vaillant heating appliance can be matched with the perfect control to ensure compliance with Boiler Plus legislation.

Vaillant's controls range from simple analogue controls to smart app-controlled models that can be integrated with smart home systems and alert you to faults. Our latest range of senso controls have been designed to be incredibly easy to use and, with a stylish contemporary design, will look beautiful wherever they're sited.

Fitting Vaillant connected controls offers the ability to remotely monitor your customers system with myVAILLANT Pro. Adding value to your service using remote diagnostics by having further insight of the system before visiting your customer.

Scan to learn more about
Vaillant controls.

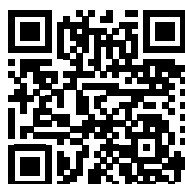

Scan to learn more about
myVAILLANT Pro.



ecoTEC exclusive with Green iQ

Combination boilers



Overview

The ecoTEC exclusive range of boilers provide great performance by intelligently managing consumption and output to keep all of its components running at peak performance, for longer, providing a low maintenance solution that you can rely on. The ecoTEC exclusive has a low carbon footprint and is more than 85% recyclable at the end of its life.

The combination range features 35 and 43kW output models, which deliver much higher-than-average heating outputs and hot water flow rates, making the ecoTEC exclusive perfect for larger properties. The design of this range allows domestic hot water to be pre-heated using what would be wasted flue gas energy, making it Boiler Plus compliant out of the box.

Features & benefits



10-year guarantee available

Free 5-year guarantee out of the box as standard. Extended guarantee available when installed with a Boiler Protection Kit and registered on Advance.



Green iQ mode

Providing outstanding eco-credentials which optimise running cycles, resulting in even lower gas consumption and lower energy bills.



Wide modulation range of up to 1:10

Adapts perfectly to all systems in every situation, ensuring lowest fuel bills for your customers.



Extra condense stainless steel heat exchanger

Takes overall combination boiler to the next level, and almost eliminates plume in DHW mode.



Easy installation and maintenance

Accessible layout allows all components to be replaced from the boiler front, with removable side panels for even more access. Step-by-step full text installation wizard helps for quicker set-up.



Self-diagnostic combustion intelligence

Includes flame lift detection for more efficient and quieter combustion.



All-gas system

As a self-adaptive system, it automatically adjusts to all types of gas, including LPG for off-gas areas.



Premium quality components

Includes brass diverter valve, ensuring highest reliability and performance.

Technical data	Unit of measure	ecoTEC exclusive 835	ecoTEC exclusive 843
General			
Boiler type		Combination	
Boiler output	kW	35	43
Article number		0010017064	0010017065
Gas Council number		47-044-66	47-044-67
Boiler dimensions (HxWxD)	mm	720 x 440 x 406	720 x 440 x 474
Performance			
NOx (En 15502-2-1)	mg/kWh	35	36
ErP efficiency (heating / DHW)	A+++ - D / A+ - F	A / A	
ErP efficiency	%	94	
ErP decibel rating (sound power)	dBa	43	51
Heating			
Nominal heat output range at 50/30°C (condensing mode)	kW	3.9 - 26.4	4.8 - 36.0
Nominal heat output range at 80/60°C (non condensing mode)	kW	3.4 - 24.6	4.3 - 33.4
Maximum flow temperature	°C	85	
Flow temperature range	°C	30 - 80	
Flow temperature factory setting	°C	75	
Approximate condensate volume at 50/30°C	Litres/hr	2.48	3.37
Modulation (max/min)	1 : X	1:10.4	1:10.1
Domestic hot water			
Maximum heat output for water generation	kW	35.3	43.4
Lowest water pressure to operate boiler	Bar	0.35	
Lowest water flow for operation	l/min	1.5	
Lowest water pressure for maximum flow rate	Bar	0.8	
Domestic hot water flow rate (at Δt = 35K)*	l/min	14.5	17.8
Hot water output temperature range	°C	35 - 65	
Mechanical			
Expansion vessel size	Litres	10	
Gas inlet connection (pipe size)	mm	15	22
Heating flow and return connections (pipe size)	mm	22	
Hot and cold water connections (pipe size)	mm	15	
Heat exchanger material	Stainless/Aluminium	Stainless steel	
Boiler lift weight (dry boiler)	kg	47.5	55.0
Maximum horizontal flue length 60/100	m	5.5	
Rear flue options	Yes/No	No	
Permissible flue classifications		C13, C33, C53	
Minimum clearances			
Side left and right	mm	5	
Top (when using 60/100 flue elbow)	mm	165	
Below	mm	180	300
Front	mm	500**	

* Vaillant combination boilers are fitted with a flow regulator set to achieve a temperature rise of 42°C. This maintains comfortable bathing and showering during the colder months of the year.

** Can be reduced to 5mm if fitted behind a door / panel which then gives 500mm once removed / opened.

ecoTEC plus

Combination boilers

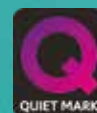









Overview

The new Vaillant ecoTEC plus combination boiler range has been refined and taken to the next level. Paired with our new plug-and-play internet gateway, myVAILLANT connect, it enables app control, smart home integration and remote appliance care and support in minutes, for increased efficiency and first-class customer service. The combination range features 26, 32, 36 and 40kW output models.

Beneath its familiar curved case, the internal layout of the new ecoTEC plus has been finely tuned to ensure all components are easily accessible, making maintenance and servicing straight forward, and installation effortless. The semi-touch interface ensures easy, intuitive operation, while enhanced connectivity opens up more possibilities for remote diagnostics, performance monitoring and control.

Features & benefits

-  **10-year guarantee available**
Free 5-year guarantee out of the box as standard. Extended guarantee available when installed with a Boiler Protection Kit and registered on Advance.
-  **Smart home ready when used with myVAILLANT connect**
The myVAILLANT connect internet gateway accessory works seamlessly with this range of ecoTEC plus boilers enabling easy connection to Vaillant controls with app connectivity and smart speaker integration* in minutes.
-  **Familiar footprint and external layout**
Retaining the same case dimensions, boiler footprint, flue position and pipe connections for an effortless like-for-like swap.
-  **New intuitive semi-touch interface****
Allowing for effortless first-time installation and set-up, with guided commissioning and set up wizard and easy to follow navigation.
-  **Automatic LPG conversion on most outputs*****
Completed in minutes using the new intuitive interface, with no additional parts required.
-  **New IoniDETECT technology**
Intelligent gas combustion monitoring, helping the new ecoTEC plus reach wider modulation range of up to 1:11, for even greater system efficiency.
-  **Sharpened intelligence with LIN bus technology**
Enables more intelligent and accurate reading of flow rate and pressure differential via internal pump for improved performance.
-  **Hydrogen prepared**
Our first product range, incorporating new technology, which has been independently certified to operate with up to 20% hydrogen and other blended gas mixtures, preparing the product should the UK Government decide that these fuels have a role to play in our future energy mix.

* Compatible with the senso controls range and the VRC 700. Only for use with single heating zones.

** New interface design not compatible with the timeSWITCH 150 and timeSWITCH 160.

*** Excluding ecoTEC plus 840, 940 and 635.

Technical data	Unit of measure	ecoTEC plus 826	ecoTEC plus 832	ecoTEC plus 836	ecoTEC plus 840
General					
Boiler type		Combination			
LPG compatible	Yes/No	Yes - adaptive			No
Article number		0010036015	0010036016	0010036017	0010036018
Dimensions					
Boiler dimensions (HxWxD)	mm	720 x 440 x 352			720 x 440 x 386
Side clearance	mm	5			
Top clearance (with 60/100 flue)	mm	165			
Top clearance if using rear flue	mm	N/A			
Bottom clearance	mm	180			
Front clearance*	mm	500			
Performance					
NOx (En 15502-2-1)	mg/kWh	33.0	27.0	28.0	26.0
ErP efficiency	%	93	94		
ErP decibel rating (sound power)	dB(A)	46	45	47	49
ErP efficiency Heating / DHW	A+++ to D / A+ to F	A / A			
Heating					
Nominal heat output range at 50/30 °C (condensing mode)	kW	2.8 - 21.2	3.9 - 26.5	4.2 - 32.2	5.0 - 32.3
Nominal heat output range at 80/60 °C (non condensing mode)	kW	2.5 - 19.8	3.5 - 24.9	3.7 - 29.9	4.5 - 29.8
Flow temperature range (factory setting - 75°C)	°C	30 - 85			
Modulation (max/min)	1 : X	1:11	1:9	1:10	1:9
Domestic hot water					
Maximum heat output for water generation	kW	26.5	32.6	36.7	40.8
Lowest water pressure to operate boiler	bar	0.7			
Lowest water flow for operation	l/min	2.0			
Domestic hot water flow rate (at Δ30 °C)**	l/min	12.4	15.2	17.0	19.0
Domestic hot water flow rate (at Δ35 °C)**	l/min	10.6	13.0	14.6	16.3
Hot water output temperature range	°C	35-65			
Mechanical					
Gas inlet connection (pipe size)	mm	15			22
Heating flow and return connections (pipe size)	mm	22			
Hot and cold water connections (pipe size)	mm	15			
Heat exchanger material	Stainless/Aluminium	Stainless steel			
Filling loop supplied	Yes/No	Yes			
Boiler lift weight (dry boiler)	kg	36	37		41
Spacer frame available	Yes/No	Yes			
Fluing options					
Maximum horizontal flue length 60/100	m	10	8		
Maximum vertical flue length 60/100	m	10	8		
Maximum horizontal flue length 80/125	m	28			
Maximum vertical flue length 80/125	m	30			
Rear flue options	Yes/No	No			
Permissible flue classifications		C13, C33, C43, C53			

* Can be reduced to 5mm if fitted behind a door / panel which then gives 500mm once removed / opened.

** Vaillant combination boilers are fitted with a flow regulator set to achieve a temperature rise of 42°C. This maintains comfortable bathing and showering during the colder months of the year.

ecoTEC plus

Storage combination boiler

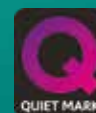

Overview

The new Vaillant ecoTEC plus storage combination boiler features a 40kW output model, which has been refined and taken to the next level. Paired with our new plug-and-play internet gateway, myVAILLANT connect, it enables app control, smart home integration and remote appliance care and support in minutes, for increased efficiency and first-class customer service.

Beneath its familiar curved case, the internal layout of the new ecoTEC plus has been finely tuned to ensure all components are easily accessible, making maintenance and servicing straight forward, and installation effortless. The semi-touch interface ensures easy, intuitive operation, while enhanced connectivity opens up more possibilities for remote diagnostics, performance monitoring and control.

Features & benefits



10-year guarantee available

Free 5-year guarantee out of the box as standard. Extended guarantee available when installed with a Boiler Protection Kit and registered on Advance.



Smart home ready when used with myVAILLANT connect

The myVAILLANT connect internet gateway accessory works seamlessly with this range of ecoTEC plus boilers enabling easy connection to Vaillant controls with app connectivity and smart speaker integration* in minutes.



Refined and enhanced internal layout

With easy access to all major components, making installation and servicing effortless.



Familiar footprint and external layout

Retaining the same case dimensions, boiler footprint, flue position and pipe connections for an effortless like-for-like swap.



New intuitive semi-touch interface**

Allowing for effortless first-time installation and set-up, with guided commissioning and set up wizard and easy to follow navigation.



New IoniDETECT technology

Intelligent gas combustion monitoring, helping the new ecoTEC plus reach wider modulation range of up to 1:9, for even greater system efficiency.



Sharpened intelligence with LIN bus technology

Enables more intelligent and accurate reading of flow rate and pressure differential via internal pump for improved performance.



Hydrogen prepared

Our first product range, incorporating new technology, which has been independently certified to operate with up to 20% hydrogen and other blended gas mixtures, preparing the product should the UK Government decide that these fuels have a role to play in our future energy mix.

Technical data	Unit of measure	ecoTEC plus 940
General		
Boiler type		Combination
LPG compatible	Yes/No	No
Article number		0010036114
Dimensions		
Boiler dimensions (HxWxD)	mm	720 x 440 x 580
Side clearance	mm	5
Top clearance (with 60/100 flue)	mm	165
Top clearance if using rear flue	mm	N/A
Bottom clearance	mm	180
Front clearance*	mm	500
Performance		
NOx (En 15502-2-1)	mg/kWh	26.0
ErP efficiency	%	94
ErP decibel rating (sound power)	dB(A)	49
ErP efficiency Heating / DHW	A+++ to D / A+ to F	A / A
Heating		
Nominal heat output range at 50/30°C (condensing mode)	kW	5.0 - 32.3
Nominal heat output range at 80/60°C (non condensing mode)	kW	4.5 - 29.8
Flow temperature range (factory setting - 75°C)	°C	30 - 85
Modulation (max/min)	1 : X	1:9
Domestic hot water		
Maximum heat output for water generation	kW	40.8
Lowest water pressure to operate boiler	bar	0.7
Lowest water flow for operation	l/min	2.0
Domestic hot water flow rate (at Δ30°C)**	l/min	21.0
Domestic hot water flow rate (at Δ35°C)**	l/min	18.0
Hot water output temperature range	°C	35-65
Mechanical		
Gas inlet connection (pipe size)	mm	22
Heating flow and return connections (pipe size)	mm	22
Hot and cold water connections (pipe size)	mm	15
Heat exchanger material	Stainless/Aluminium	Stainless steel
Filling loop supplied	Yes/No	Yes
Boiler lift weight (dry boiler)	kg	60
Spacer frame available	Yes/No	No
Fluing options		
Maximum horizontal flue length 60/100	m	8
Maximum vertical flue length 60/100	m	8
Maximum horizontal flue length 80/125	m	28
Maximum vertical flue length 80/125	m	30
Rear flue options	Yes/No	No
Permissible flue classifications		C13, C33, C43, C53

* Can be reduced to 5mm if fitted behind a door / panel which then gives 500mm once removed / opened.

** Vaillant combination boilers are fitted with a flow regulator set to achieve a temperature rise of 42°C. This maintains comfortable bathing and showering during the colder months of the year.

ecoTEC pro

Combination boilers











Overview

The ecoTEC pro range of combination boilers combines the built-in quality, reliability, and performance you'd expect from Vaillant, with a simple design and approach. The range includes an LPG model, and is also compatible with our aroTHERM heat pump range, so it's perfect for off-grid properties.

The combination range features 24, 28 and 30kW output models, making this the perfect boiler for homes with smaller heating and hot water requirements. The ecoTEC pro combination boiler range offers versatile siting options, with ease of installation and service with a push-fit flue system and removable side panels to make life that much easier.

Features & benefits

- **7-year guarantee available**
Standard 2-year guarantee, can be upgraded to a free 7-year guarantee when registered through Vaillant Advance.
- **Boiler Plus compliant with Vaillant controls**
Install with sensoHOME*, sensoCOMFORT, vSMART or VRC 700 for a weather compensated system.
- **Patented stainless steel heat exchanger**
Provides superior heat transfer and highly efficient performance.
- **Easy installation and maintenance**
Accessible layout allows all components to be replaced from the boiler front, with removable side panels for even more access. Step-by-step full text installation wizard helps for quicker set-up.
- **60/100 push fit flue system with full range of accessories**
80/125 flue adaptor and system for even longer lengths and installation flexibility.
- **Built-in two-stage frost protection**
Ensures optimal performance all year round.
- **Features Vaillant's exclusive AquaComfort system**
Provides quick delivery of hot water at a constant temperature, which reduces unnecessary water wastage.
- **Electronic gas and air modulation system**
Allows precise self-setting gas combustion to improve performance and lower emissions.

* Outdoor sensor sold separately and only for single zone systems

Technical data	Unit of measure	ecoTEC pro 24	ecoTEC pro 28	ecoTEC pro 28 LPG	ecoTEC pro 30
General					
Boiler type		Combination			
Boiler output	kW	24	28		30
Article number		0010021836	0010021837	0010021838	0010016538
Gas Council number		47-044-88	47-044-89	47-044-90	47-044-52
Boiler dimensions (HxWxD)	mm	720 x 440 x 338			
Performance					
NOx (En 15502-2-1)	mg/kWh	27		28	30
ErP efficiency (heating / DHW)	A+++ - D / A+ - F	A / A			
ErP efficiency	%	94			93
ErP decibel rating (sound power)	dBa	49			
Heating					
Nominal heat output range at 50/30°C (condensing mode)	kW	5.9 - 24.8	5.9 - 25.9	7.9 - 25.3	6.9 - 25.7
Nominal heat output range at 80/60°C (non condensing mode)	kW	5.2 - 23.0	5.2 - 24.0	7.2 - 24.0	6.2 - 24.4
Maximum flow temperature	°C	85			
Flow temperature range	°C	30 - 80			
Flow temperature factory setting	°C	75			
Approx. condensate volume at 50/30°C	Litres/hr	1.9			2.5
Modulation (max/min)	1 : X	1:4.4	1:5.1	1:3.7	1:3.8
Domestic hot water					
Maximum heat output for water generation	kW	23.7	27.5	27.5	30.3
Lowest water pressure to operate boiler	Bar	0.35			
Lowest water flow for operation	l/min	2			
Lowest water pressure for maximum flow rate	Bar	0.8			
Domestic hot water flow rate (at Δt = 35K)*	l/min	9.6	11.1	11.1	12.3
Hot water output temperature range	°C	35 - 65			
Mechanical					
Expansion vessel size	Litres	10			
Gas inlet connection (pipe size)	mm	15			
Heating flow and return connections (pipe size)	mm	22			
Hot and cold water connections (pipe size)	mm	15			
Heat exchanger material	Stainless/Aluminium	Stainless steel			
Boiler lift weight (dry boiler)	kg	38			39
Maximum horizontal flue length 60/100	m	12			
Rear flue options	Yes/No	No			
Permissible flue classifications		C13, C33, C43, C53			
Minimum clearances					
Side left and right	mm	5			
Top	mm	165			
Below	mm	180			
Front	mm	500**			

* Vaillant combination boilers are fitted with a flow regulator set to achieve a temperature rise of 42°C. This maintains comfortable bathing and showering during the colder months of the year.

** Can be reduced to 5mm if fitted behind a door / panel which then gives 500mm once removed / opened.

ecoFIT pure

Combination boilers



Overview

The ecoFIT pure range of combination boilers is ultra-quiet in operation and has a small footprint, proving total flexibility of siting. The rear and top flue option means this boiler range is the perfect solution for fitting inside a standard kitchen cupboard unit.

The combination range features 25, 30 and 35kW output models, and is made from high quality, highly efficient components. Complete with availability of spare parts and an accessible layout, the ecoFIT pure is easy to maintain and service.

The automatic purging assistant and high specification, automotive grade, aluminum heat exchanger makes for a lightweight installation.

Features & benefits



10-year guarantee available

Free 2-year guarantee out of the box as standard. Extended guarantee available when installed with a Boiler Protection Kit and registered on Advance.



Easy installation and maintenance

Accessible layout allows all components to be replaced from the boiler front, with removable side panels for even more access and reduced installation time.



Boiler Plus compliant with Vaillant controls

Install with sensoHOME, VRT 350 or timeSWITCH 150 and sensoROOM pure for a load compensated system.



60/100 push fit flue system with full range of accessories

80/125 flue system option for even longer lengths and installation flexibility.



Compact, cupboard fit solution

A smaller footprint, cupboard fit dimensions and top and rear flue options offer flexibility of siting with rear and top flue option.



Pneumatic gas and air modulation system

For precise self-setting gas combustion to improve performance and lower emissions.



High specification aluminium heat exchanger

Designed for longer life, easier maintenance, and lower energy bills.



4-sided cooling and water agitation of the heat exchanger

Reducing stress on the heat exchanger for longer life, reliability, and reduced maintenance costs.

Technical data	Unit of measure	ecoFIT pure 825	ecoFIT pure 830	ecoFIT pure 835
General				
Boiler type		Combination		
Boiler output	kW	25	30	35
Article number		0010020389	0010020390	0010020391
Gas Council number		47-044-68	47-044-74	47-044-70
Boiler dimensions (HxWxD)	mm	702 x 390 x 295		
Performance				
NOx (En 15502-2-1)	mg/kWh	39	39	39
ErP efficiency (heating / DHW)	A+++ - D / A+ - F	A / A		
ErP efficiency	%	94		
ErP decibel rating (sound power)	dBa	49	51	52
Heating				
Nominal heat output range at 50/30°C (condensing mode)	kW	5.3 - 19.1	6.3 - 26.5	7.5 - 26.7
Nominal heat output range at 80/60°C (non condensing mode)	kW	5.1 - 18.3	6.1 - 25.4	7.2 - 25.5
Maximum flow temperature	°C	80		
Flow temperature range	°C	10-80		
Flow temperature factory setting	°C	75		
Approximate condensate volume at 50/30°C	Litres/hr	1.84	2.55	2.57
Modulation (max/min)	1 : X	1:5	1:5	1:5
Domestic hot water				
Maximum heat output for water generation	kW	25.7	30.6	35.7
Lowest water pressure to operate boiler	Bar	0.3		
Lowest water flow for operation	l/min	2		
Lowest water pressure for maximum flow rate	Bar	2		
Domestic hot water flow rate (at Δt = 35K)*	l/min	10.4	12.2	14.1
Hot water output temperature range	°C	35 - 60		
Mechanical				
Expansion vessel size	Litres	8		
Gas inlet connection (pipe size)	mm	15		
Heating flow and return connections (pipe size)	mm	22		
Hot and cold water connections (pipe size)	mm	15		
Heat exchanger material	Stainless/ Aluminium	Aluminium		
Boiler lift weight (dry boiler)	kg	32	33	
Maximum horizontal flue length 60/100	m	10		
Rear flue options	Yes/No	Yes		
Permissible flue classifications		C13, C33, C43, C53		
Minimum clearances				
Side left and right	mm	5		
Top	mm	150		
Top (if using rear flue)	mm	20		
Below	mm	150		
Front	mm	500**		

* Vaillant combination boilers are fitted with a flow regulator set to achieve a temperature rise of 42°C. This maintains comfortable bathing and showering during the colder months of the year.

** Can be reduced to 5mm if fitted behind a door / panel which then gives 500mm once removed / opened.

ecoTEC exclusive with Green iQ

System boiler

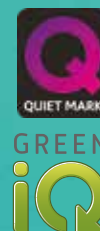









Overview

The ecoTEC exclusive system boiler combines our complete range of smart technologies and features, providing great performance by intelligently managing consumption and output to keep all of its components running at peak performance, for longer, providing a low maintenance solution that you can rely on. The ecoTEC exclusive has a low carbon footprint and is more than 85% recyclable at the end of its life.

The ecoTEC exclusive system boiler is available with 27kW output and includes an integrated diverter valve for the first time in UK Vaillant history.

Features & benefits

-  **10-year guarantee available**
Free 5-year guarantee out of the box as standard. Extended guarantee available when installed with a Boiler Protection Kit and registered on Advance.
-  **Green iQ mode**
Providing outstanding eco-credentials which optimise running cycles, resulting in even lower gas consumption and lower energy bills.
-  **Wide modulation range of up to 1:10**
Adapts perfectly to all systems in every situation, ensuring lowest fuel bills for your customers.
-  **Extra condense stainless steel heat exchanger**
Provides superior heat transfer and highly efficient performance.

-  **Easy installation and maintenance**
Accessible layout allows all components to be replaced from the boiler front, with removable side panels for even more access. Step-by-step full text installation wizard helps for quicker set-up.
-  **All-gas system**
Always reaches optimal combustion with lowest emissions. As a self-adaptive system, it automatically adjusts to all types of gas.
-  **Integrated three-way valve**
Four-pipe system with load compensation in DHW and CH modes. No more complex wiring systems, junction boxes or external zone valves.
-  **60/100 push fit flue system with full range of accessories**
80/125 flue system option for even longer lengths and installation flexibility.

Technical data	Unit of measure	ecoTEC exclusive 627
General		
Boiler type		System
Boiler output	kW	27
Article number		0010017063
Gas Council number		41-694-02
Boiler dimensions (HxWxD)	mm	720 x 440 x 338
Performance		
NOx (En 15502-2-1)	mg/kWh	30
ErP efficiency (heating)	A+++ - D	A
ErP efficiency	%	94
ErP decibel rating (sound power)	dBa	46
Heating		
Nominal heat output range at 50/30°C (condensing mode)	kW	3.4 - 26.7
Nominal heat output range at 80/60°C (non condensing mode)	kW	3.0 - 24.7
Maximum flow temperature	°C	85
Flow temperature range	°C	30 - 80
Flow temperature factory setting	°C	75
Approximate condensate volume at 50/30°C	Litres/hr	2.52
Modulation (max/min)	1 : X	1:10
Mechanical		
Expansion vessel size	Litres	10
Gas inlet connection (pipe size)	mm	15
Heating flow and return connections (pipe size)	mm	22
Heat exchanger material	Stainless/Aluminium	Stainless steel
Boiler lift weight (dry boiler)	kg	37.5
Maximum horizontal flue length 60/100	m	5.5
Rear flue options	Yes/No	No
Permissible flue classifications		C13, C33, C53
Minimum clearances		
Side left and right	mm	5
Top	mm	165
Below	mm	180
Front	mm	500*

* Can be reduced to 5mm if fitted behind a door / panel which then gives 500mm once removed / opened.

ecoTEC plus

System boilers



Overview

The new Vaillant ecoTEC plus system boiler range has been refined and taken to the next level. Paired with our new plug-and-play internet gateway, myVAILLANT connect, it enables app control, smart home integration and remote appliance care and support in minutes, for increased efficiency and first-class customer service. The system range features 10, 15, 20, 25, 30 and 35kW output models, higher DHW outputs are achievable when using Vaillant controls (with eBUS protocol).

Beneath its familiar curved case, the internal layout of the new ecoTEC plus has been finely tuned to ensure all components are easily accessible, making maintenance and servicing straight forward, and installation effortless. The semi-touch interface ensures easy, intuitive operation, while enhanced connectivity opens up more possibilities for remote diagnostics, performance monitoring and control.

Features & benefits



10-year guarantee available

Free 5-year guarantee out of the box as standard. Extended guarantee available when installed with a Boiler Protection Kit and registered on Advance.



Smart home ready when used with myVAILLANT connect

The myVAILLANT connect internet gateway accessory works seamlessly with this range of ecoTEC plus boilers enabling easy connection to Vaillant controls with app connectivity and smart speaker integration* in minutes.



Familiar footprint and external layout

Retaining the same case dimensions, boiler footprint, flue position and pipe connections for an effortless like-for-like swap.



New intuitive semi-touch interface**

Allowing for effortless first-time installation and set-up, with guided commissioning and set up wizard and easy to follow navigation.



Automatic LPG conversion on most outputs***

Completed in minutes using the new intuitive interface, with no additional parts required.



New IoniDETECT technology

Intelligent gas combustion monitoring, helping the new ecoTEC plus reach wider modulation range of up to 1:9 for even greater system efficiency.



Sharpened intelligence with LIN bus technology

Enables more intelligent and accurate reading of flow rate and pressure differential via internal pump for improved performance.



Hydrogen prepared

Our first product range, incorporating new technology, which has been independently certified to operate with up to 20% hydrogen and other blended gas mixtures, preparing the product should the UK Government decide that these fuels have a role to play in our future energy mix.

* Compatible with the senso controls range and the VRC 700. Only for use with single heating zones.

** New interface design not compatible with the timeSWITCH 150 and timeSWITCH 160.

*** Excluding ecoTEC plus 840, 940 and 635.

Technical data	Unit of measure	ecoTEC plus 610	ecoTEC plus 615	ecoTEC plus 620	ecoTEC plus 625	ecoTEC plus 630	ecoTEC plus 635	
General								
Boiler type		System						
LPG compatible	Yes/No	Yes - adaptive					No	
Article number		0010036009	0010036010	0010036011	0010036012	0010036013	0010036014	
Dimensions								
Boiler dimensions (HxWxD)	mm	720 x 440 x 352					720 x 440 x 386	
Side clearance	mm	5						
Top clearance (with 60/100 flue)	mm	165						
Top clearance if using rear flue	mm	N/A						
Bottom clearance	mm	180						
Front clearance*	mm	500						
Performance								
NOx (En 15502-2-1)	mg/kWh	36.0	36.0	33.0	27.0	28.0	27.0	
ErP efficiency	%	92	93		94			
ErP decibel rating (sound power)	dB(A)	37	42	45	46	48	52	
ErP efficiency Heating / DHW	A+++ to D / A+ to F	A / A						
Heating								
Nominal heat output range at 50/30°C (condensing mode)	kW	2.8 - 10.6	2.8 - 15.9	2.8 - 21.2	3.9 - 26.5	4.2 - 32.2	5.0 - 37.7	
Nominal heat output range at 80/60°C (non condensing mode)	kW	2.5 - 9.9	2.5 - 14.8	2.5 - 19.8	3.5 - 24.9	3.7 - 29.9	4.5 - 34.9	
Flow temperature range (factory setting - 75°C)	°C	30 - 85						
Modulation (max/min)	1 : X	1:8		1:9	1:8	1:9		
Domestic hot water								
Maximum heat output for water generation	kW	19.6	19.6	23.6	29.6	34.3	39.4	
Mechanical								
Gas inlet connection (pipe size)	mm	15					22	
Heating flow and return connections (pipe size)	mm	22						
Heat exchanger material	Stainless/Aluminium	Stainless steel						
Filling loop supplied	Yes/No	No						
Boiler lift weight (dry boiler)	kg	34			36		40.5	
Spacer frame available	Yes/No	Yes						
Fluing options								
Maximum horizontal flue length 60/100	m	16			8			
Maximum vertical flue length 60/100	m	12			8			
Maximum horizontal flue length 80/125	m	28						
Maximum vertical flue length 80/125	m	30						
Rear flue options	Yes/No	No						
Permissible flue classifications		C13, C33, C43, C53						

* Can be reduced to 5mm if fitted behind a door / panel which then gives 500mm once removed / opened.

ecoTEC plus

Large output system boilers











Overview

The ecoTEC plus range of system boilers are compact in size and extremely lightweight compared to its predecessors. The front and side panels can be removed, allowing for much easier access in tight and restrictive spaces.

The internal ducted rain collector prevents rain ingress from the flue system depositing in the boiler casing, and the gunmetal air separation device prevents unwanted vented emissions within the case, both of which helps to protect the electronics inside the boiler.

The larger output system range features 48 and 64kW output models and can be cascaded for projects that require outputs above 70kW. Individually, these boilers can be installed by a Gas Safe registered engineer with a Gas Safe certificate, so is a great way for installers to diversify into larger output installations.

Features & benefits

-  **5-year guarantee available**
Free 5-year guarantee out of the box as standard.
-  **Highly efficient stainless steel heat exchanger**
Allows lower running costs whilst using the familiar, reliable, and robust heat exchanger design.
-  **Easy installation and maintenance**
Accessible layout allows all components to be replaced from the boiler front, with removable side panels for even more access. Step-by-step full text installation wizard helps for quicker set-up.
-  **Push fit flue system with industry leading flue lengths**
80/125 flue adaptor and system for even longer lengths and installation flexibility.
-  **Electronic gas and air modulation system**
Allows precise self-setting gas combustion to improve performance and lower emissions.
-  **Compatible with Vaillant's heat pump range**
Can be fitted with an aroTHERM heat pump to create a hybrid system.
-  **Low NOx burner system**
Levels as low as 29mg/kWh to minimise environmental impacts.
-  **Compatible with LPG**
A perfect solution for off-gas areas.

Technical data	Unit of measure	ecoTEC plus 48	ecoTEC plus 64
General			
Boiler type		System	
Boiler output	kW	48	64
Article number		0010021520	0010021521
Gas Council number		41-694-28	41-694-29
Boiler dimensions (HxWxD)	mm	720 x 440 x 405	720 x 440 x 473
Performance			
NOx Class 6 (En 15502-2-1)	mg/kWh	30.8	29.1
ErP efficiency* (heating)	A+++ - D	A+	
ErP efficiency	%	94	
ErP decibel rating (sound power)	dBa	57	
Heating			
Nominal heat output range at 50/30°C (condensing mode)	kW	8.7 - 48.0	12.2 - 63.5
Nominal heat output range at 80/60°C (non condensing mode)	kW	7.8 - 44.1	11.0 - 58.7
Conversion to LPG G31 at 37mb at 50/30°C (Conversion kit by installer on site necessary)	kW	8.6 - 46.6	12.0 - 62.1
Conversion to LPG G31 at 37mb at 80/60°C (Conversion kit by installer on site necessary)	kW	7.8 - 44.0	11.0 - 58.4
Maximum flow temperature	°C	80	
Flow temperature range	°C	30 - 80	
Flow temperature factory setting	°C	75	
Approximate condensate volume at 50/30°C	Litres/hr	5.0	6.9
Modulation (max/min)	1 : X	1:5.5 (18%)	1:5.2 (19%)
Lowest water pressure to operate boiler	bar	0.8	
Nominal flow rate (at DT = 20K)	l/hr	1900	2500
Mechanical			
Expansion vessel size	Litres	Not supplied	
Gas inlet connection (pipe size)	BSP female	1"	
Heating flow and return connections (pipe size)	BSP female	1 1/4"	
Heat exchanger material	Stainless/Aluminium	Stainless steel	
Boiler lift weight (dry boiler - includes pump)	kg	38	48
Maximum horizontal flue length 80/125	m	18	15
Maximum vertical flue length 80/125	m	21	18
Rear flue options	Yes/No	No	
Permissible flue classifications		C13, C33, C43, C53, C93, B23, B23p, B53, B53p	
Minimum clearances			
Side left and right	mm	5	
Top	mm	350	
Top (if using rear flue)	mm	-	
Below	mm	400	
Front	mm	500**	

* When installed with a class VI control.

** Can be reduced to 5mm if fitted behind a door / panel which then gives 500mm once removed / opened.

ecoFIT pure

System boilers



Overview

The ecoFIT pure range of system boilers is ultra-quiet in operation and has a small footprint, proving total flexibility of siting. The rear and top flue option means this boiler range is the perfect solution for fitting inside a standard kitchen cupboard unit.

The system range features 12, 15, 18, 25 and 30kW output models, and is made from high quality, highly efficient components. Complete with availability of spare parts and an accessible layout, the ecoFIT pure is easy to maintain and service.

The automatic purging assistant and high specification, automotive grade, aluminum heat exchanger makes for a lightweight installation.

Features & benefits



10-year guarantee available

Free 2-year guarantee out of the box as standard. Extended guarantee available when installed with a Boiler Protection Kit and registered on Advance.



Compact, cupboard fit solution

A smaller footprint, cupboard fit dimensions and top and rear flue options offer flexibility of siting.



High specification aluminium heat exchanger

Designed for longer life, easier maintenance, and lower energy bills.



Easy installation and maintenance

Accessible layout allows all components to be replaced from the boiler front, with removable side panels for even more access.



60/100 push fit flue system with full range of accessories

80/125 flue system option for even longer lengths and installation flexibility.



Pneumatic gas and air modulation system

For precise self-setting gas combustion to improve performance and lower emissions.



4-sided cooling and water agitation of the heat exchanger

Reducing stress on the heat exchanger for longer life, reliability, and reduced maintenance costs.

Technical data	Unit of measure	ecoFIT pure 612	ecoFIT pure 615	ecoFIT pure 618	ecoFIT pure 625	ecoFIT pure 630
General						
Boiler type		System				
Boiler output	kW	12	15	18	25	30
Article number		0010020395	0010020396	0010020397	0010020398	0010020399
Gas Council number		41-694-03	41-694-04	41-694-05	41-694-06	41-694-07
Boiler dimensions (HxWxD)	mm	702 x 390 x 295				
Performance						
NOx (En 15502-2-1)	mg/kWh	32	33	39		40
ErP efficiency (heating)	A+++ - D	A				
ErP efficiency	%	94				
ErP decibel rating (sound power)	dBa	45	48	49	51	54
Heating						
Nominal heat output range at 50/30°C (condensing mode)	kW	4.7 - 12.8	4.7 - 15.9	5.2 - 19.1	6.4 - 26.5	7.5 - 31.8
Nominal heat output range at 80/60°C (non condensing mode)	kW	4.5 - 12.2	4.5 - 15.2	5.0 - 18.3	6.1 - 25.4	7.1 - 30.2
Maximum flow temperature	°C	80				
Flow temperature range	°C	10 - 80				
Flow temperature factory setting	°C	75				
Approximate condensate volume at 50/30°C	Litres/hr	1.23	1.53	1.84	2.55	3.06
Modulation (max/min)	1 : X	1:3.3	1:4	1:5	1:4.9	1:4.9
Mechanical						
Expansion vessel size	Litres	8				
Gas inlet connection (pipe size)	mm	15				
Heating flow and return connections (pipe size)	mm	22				
Heat exchanger material	Stainless/Aluminium	Aluminium				
Boiler lift weight (dry boiler)	kg	31			32	
Maximum horizontal flue length 60/100	m	10				
Rear flue options	Yes/No	Yes				
Permissible flue classifications		C13, C33, C43, C53				
Minimum clearances						
Side left and right	mm	5				
Top	mm	150				
Top (if using rear flue)	mm	20				
Below	mm	150				
Front	mm	500*				

* Can be reduced to 5mm if fitted behind a door / panel which then gives 500mm once removed / opened.

ecoTEC plus

Open vent boilers



Overview

The ecoTEC plus range of open vent boilers is extremely reliable, with the quality of components and manufacturing that Vaillant is known for. Thanks to continuous modulation and real combustion control by a multi-sensor system, they achieve high efficiency with the lowest emissions. These boilers have an aluminium heat exchanger with wide waterways: an ideal choice for larger properties.

The open vent range features 12, 15, 18, 24 and 30kW output models, meeting the heating requirements of varying house sizes. Each one is ultra-quiet a feature recognised by the Noise Abatement Society, which has awarded many of the ecoTEC plus range with the Quiet Mark accreditation for its innovative design, specifically created to ensure a peaceful home for your customers.

Features & benefits



10-year guarantee available

Free 5-year guarantee out of the box as standard. Extended guarantee available when installed with a Boiler Protection Kit and registered on Advance.



Electronic gas and air modulation system

For precise self-setting gas combustion to improve performance and lower emissions.



High specification aluminium heat exchanger

Designed for longer life, easier maintenance, and lower energy bills.



Compatible with Vaillant's heat pump range

Can be fitted with an aroTHERM heat pump to create a hybrid system.



Easy installation and maintenance

Accessible layout allows all components to be replaced from the boiler front, with removable side panels for even more access.



Dedicated models available for LPG

A perfect solution for off-gas areas.



60/100 push fit flue system with full range of accessories

80/125 flue system option for even longer lengths and installation flexibility.

Technical data	Unit of measure	ecoTEC plus 412	ecoTEC plus 415	ecoTEC plus 418	ecoTEC plus 424	ecoTEC plus 424 LPG	ecoTEC plus 430	ecoTEC plus 435
General								
Boiler type		Open vent						
Boiler output	kW	12	15	18	24		30	35
Article number		0010021220	0010021221	0010021222	0010021223	0020231355	0010021224	0010015674
Gas Council number		41-694-13	41-694-14	41-694-15	41-694-16	41-694-18	41-694-17	41-044-76
Boiler dimensions (HxWxD)	mm	602 x 375 x 320						
Performance								
NOx (En 15502-2-1)	mg/kWh	32	33	39	39	35	40	29
ErP efficiency (heating)	A+++ - D	A						
ErP efficiency	%	94						
ErP decibel rating (sound power)	dBa	45	48	51	52	49	55	53
Heating								
Nominal heat output range at 50/30°C (condensing mode)	kW	4.7 - 12.8	4.7 - 15.9	5.2 - 19.1	6.3 - 25.7	8.0 - 25.7	7.5 - 31.8	7.5 - 37.1
Nominal heat output range at 80/60°C (non condensing mode)	kW	4.5 - 12.3	4.5 - 15.2	5.0 - 18.3	6.1 - 24.6	7.6 - 24.3	7.2 - 30.5	7.1 - 35.1
Maximum flow temperature	°C	80						
Flow temperature range	°C	10 - 80						
Flow temperature factory setting	°C	75						
Approximate condensate volume at 50/30°C	Litres/hr	1.23	1.53	1.84	2.47		3.06	3.57
Modulation (max/min)	1 : X	1:4.1	1:4.1	1:5.1	1:5	1:4	1:5	1:5
Mechanical								
Gas inlet connection (pipe size)	mm	15						
Heating flow and return connections (pipe size)	mm	22						
Heat exchanger material	Stainless/Aluminium	Aluminium						
Boiler lift weight (dry boiler)	kg	23.0			23.0			
Maximum horizontal flue length 60/100	m	10				0.7*	10	
Rear flue options	Yes/No	Yes				No	Yes	
Permissible flue classifications		C13, C33, C43, C53 (LPG option is only suitable for C13 classification and can only be fitted with the top mounted horizontal flue supplied)						
Minimum clearances								
Side left and right	mm	5						
Top	mm	150						
Top (if using rear flue)	mm	75						
Below	mm	150						
Front	mm	500*						

* Can be reduced to 5mm if fitted behind a door / panel which then gives 500mm once removed / opened.

ecoFIT pure

Open vent boilers



Overview

The ecoFIT pure range of open vent boilers has a wide range of outputs to choose from with 12, 15, 18, 25, 30 and 35kW output models available. With ultra-quiet operation, a small footprint and flexible siting options (including a choice of top or rear flues), the ecoFIT pure range has a model to fit your customers' needs.

The automatic purging assistance and high specification, aluminium heat exchanger make for a lightweight installation.

High quality and high efficiency, together with the complete availability of spare parts and the easy accessibility of the unit layout means the ecoFIT pure is easy to maintain too.

Features & benefits



10-year guarantee available

Free 2-year guarantee out of the box as standard. Extended guarantee available when installed with a Boiler Protection Kit and registered on Advance.



Compact, cupboard fit solution

A smaller footprint, cupboard fit dimensions and top and rear flue options offer flexibility of siting.



High specification aluminium heat exchanger

Designed for longer life, easier maintenance, and lower energy bills.



Easy installation and maintenance

Accessible layout allows all components to be replaced from the boiler front, with removable side panels for even more access.



60/100 push fit flue system with full range of accessories

80/125 flue system option for even longer lengths and installation flexibility.



Pneumatic gas and air modulation system

For precise self-setting gas combustion to improve performance and lower emissions.



4-sided cooling and water agitation of the heat exchanger

Reducing stress on the heat exchanger for longer life, reliability, and reduced maintenance costs.

Technical data	Unit of measure	ecoFIT pure 412	ecoFIT pure 415	ecoFIT pure 418	ecoFIT pure 425	ecoFIT pure 430	ecoFIT pure 435
General							
Boiler type		Open vent					
Boiler output	kW	12	15	18	25	30	35
Article number		0010020400	0010020401	0010020402	0010020403	0010020404	0010020405
Gas Council number		41-694-08	41-694-09	41-694-10	41-694-11	41-694-12	41-694-19
Boiler dimensions (HxWxD)	mm	602 x 375 x 295					
Performance							
NOx (En 15502-2-1)	mg/kWh	32	33	39	39	40	32
ErP efficiency (heating)	A+++ - D	A					
ErP efficiency	%	94					
ErP decibel rating (sound power)	dBa	45	48	51	52	55	
Heating							
Nominal heat output range at 50/30°C (condensing mode)	kW	4.7 - 12.8	4.7 - 15.9	5.2 - 19.1	6.4 - 26.5	7.4 - 31.8	7.0 - 35.8
Nominal heat output range at 80/60°C (non condensing mode)	kW	4.5 - 12.2	4.5 - 15.2	5.0 - 18.3	6.1 - 25.4	7.1 - 30.2	7.2 - 34.8
Maximum flow temperature	°C	80					
Flow temperature range	°C	10 - 80					
Flow temperature factory setting	°C	75					
Approximate condensate volume at 50/30°C	Litres/hr	1.23	1.53	1.84	2.55	3.06	3.65
Modulation (max/min)	1 : X	1:3.3	1:4	1:5	1:4.9		
Mechanical							
Gas inlet connection (pipe size)	mm	15					
Heating flow and return connections (pipe size)	mm	22					
Heat exchanger material	Stainless/ Aluminium	Aluminium					
Boiler lift weight (dry boiler)	kg	22					23
Maximum horizontal flue length 60/100	m	10					
Rear flue options	Yes/No	Yes					
Permissible flue classifications		C13, C33, C43, C53					
Minimum clearances							
Side left and right	mm	5					
Top	mm	150					
Top (if using rear flue)	mm	75					
Below	mm	150					
Front	mm	500*					

* Can be reduced to 5mm if fitted behind a door / panel which then gives 500mm once removed / opened.

Terminal clearances

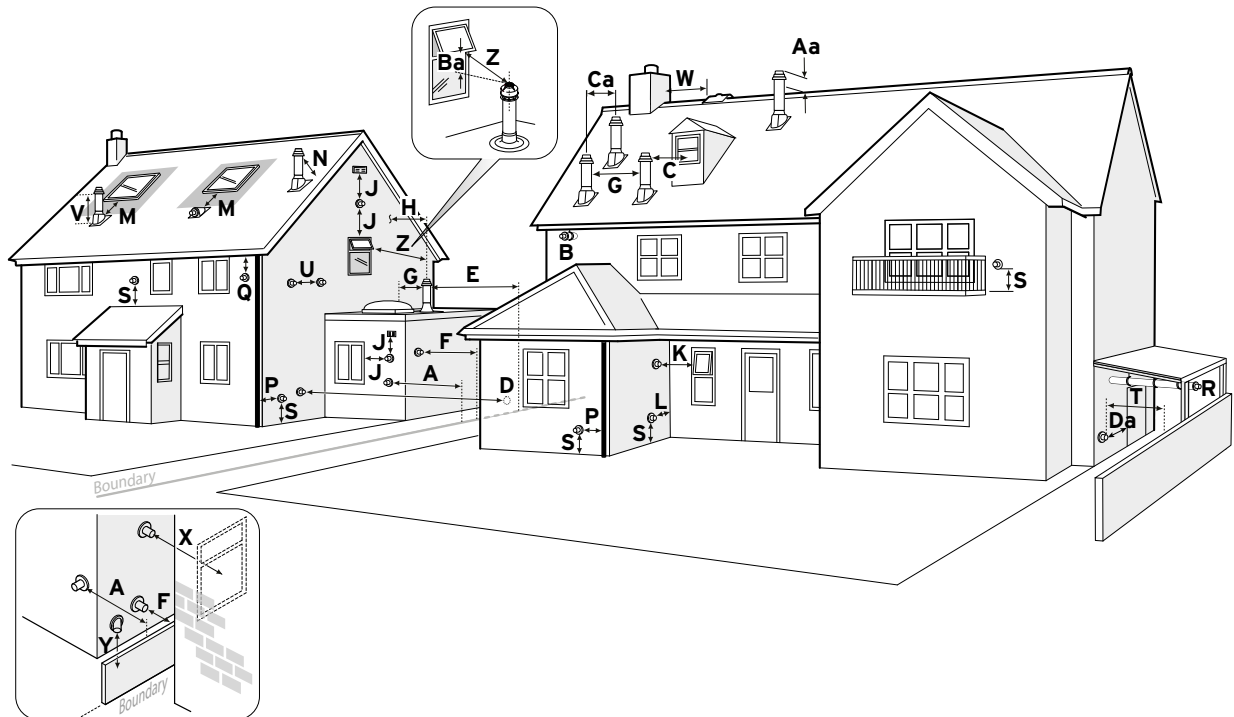

A	300	300mm adjacent to a boundary.
B	25 ⁽¹⁾	The dimension below eaves, balconies and car ports can be reduced to 25mm, as long as the flue terminal is extended to clear any overhang. External flue joints must be sealed with a suitable silicon sealant.
C	1500	1500mm between a vertical flue terminal and a window or dormer window on a roof.
D	1200	1200mm between terminals facing each other.
E	300	Vertical flue clearance, 300mm adjacent to a boundary line.
F ⁽²⁾	600	600mm distance to a boundary line, unless it will cause a nuisance. BS 5440:Part 1 recommends that care is taken when siting terminal in relation to boundary lines.
G	300	300mm minimum clearance from a skylight to a vertical flue or to another adjacent vertical flue.
H	500 1500	500mm vertical flue clearance, to non-combustible building material. 1500mm vertical flue clearance to combustible building material.
J	300	300mm above, below and either side of an opening door, air vent or opening window.
K	600	600mm diagonally to an opening door, air vent or opening window.
L ⁽²⁾	200	200mm to an internal or external corner.*
M	2000 600	2000mm below a Velux window. 600mm above or to either side of the Velux window.
N	400 500	400mm from a pitched roof. 500mm in regions with heavy snowfall.
P	25	25mm from vertical drain pipes and soil pipes.

* This distance can be reduced to 25mm by using a plume kit or diverter and being angled at 45° to avoid staining.

Note: Terminal must NOT terminate under roof or car port. Car port must have at least two open sides.

(1) There should be no ventilation/opening in the eaves within 300mm distance of the terminal.

Q ⁽¹⁾	200 75	200mm below eaves. 75mm below gutters, pipe and drains. (see also 'R').
R	25	The dimension below eaves, balconies and car ports can be reduced to 25mm, as long as the flue terminal is extended to clear any overhang. External flue joints must be sealed with suitable silicon sealant.
S	300	300mm above adjacent ground or balcony.
T ⁽²⁾	600	600mm distance to a surface facing a terminal, unless it will cause a nuisance. BS 5440: Part 1 recommends that care is taken when siting terminals in relation to surfaces facing a terminal.
U	300	300mm clearance alongside another terminal.
V	300	300mm above roof level.
W	300	300mm min to vertical structure on roof, roof vent.
X	2000	2000mm min. to opening in adjacent building.
Y	600	600mm min. at an angle to a boundary which is not less than 300mm to the terminal.
Z	600	600mm min. measured to the nearest corner of the open window.
Aa	300	No more than 300mm above ridge.
Ba	300	No less than 300mm below the opening window.
Ca	600	600mm between vertical flues.
Da	1200	From an opening (e.g. door window etc.) in eaves, balconies, car ports and overhangs.

(2) These dimensions comply with the building regulations, but they may need to be increased to avoid wall staining and nuisance from pluming depending on site conditions.

- All measurements are the minimum clearances required.
- Terminals must be positioned so to avoid combustion products entering the building.
- Support the flue at approximately one metre intervals and at a change of direction, use suitable brackets and fixings.
- Installations in car ports are not recommended.
- The flue cannot be lower than 1 metre from the top of a lightwell due to the build up of combustion products.
- Dimensions from a flue terminal to a fanned air inlet to be determined by the ventilation equipment.
- The terminal clearances are only applicable where the appliance has been installed, commissioned and maintained inline with the manufacturer's instructions.

Flue lengths

Technical data	Horizontal flues		Vertical flues	
Diameter	60/100 DN	80/125 DN	60/100 DN	80/125 DN
Combination boilers				
ecoTEC exclusive 835 and 843	5.5m	32m	8m	34m
ecoTEC plus 826	10m	28m	10m	30m
ecoTEC plus 832, 836, 840 and 940	8m	28m	8m	30m
ecoTEC pro 24, 28 and 30	12m	39m	16m	41m
ecoFIT pure 825, 830 and 835	10m	25m	10m	25m
System boilers				
ecoTEC exclusive 627	5.5m	32m	8m	34m
ecoTEC plus 610, 615 and 620	16m	28m	12m	30m
ecoTEC plus 625, 630 and 635	8m	28m	8m	30m
ecoTEC plus 48	-	18m	-	21m
ecoTEC plus 64	-	15m	-	18m
ecoFIT pure 612, 615, 618, 625 and 630	10m	25m	10m	25m
Open vent boilers				
ecoTEC plus 412, 415, 418, 425, 430 and 435	10m	25m	10m	25m
ecoFIT pure 412, 415, 418, 425, 430 and 435	10m	25m	10m	25m

Please note: there will be reductions in the maximum length of flues if elbows etc are required in the design. See the individual flue guides for further information.

if you are replacing an existing boiler with a 2023 ecoTEC plus model, make sure the flue run is compatible with the new boilers flue length. If you have any questions, please speak to your local Vaillant Regional Business Manager.

Flue solutions

Flue accessories

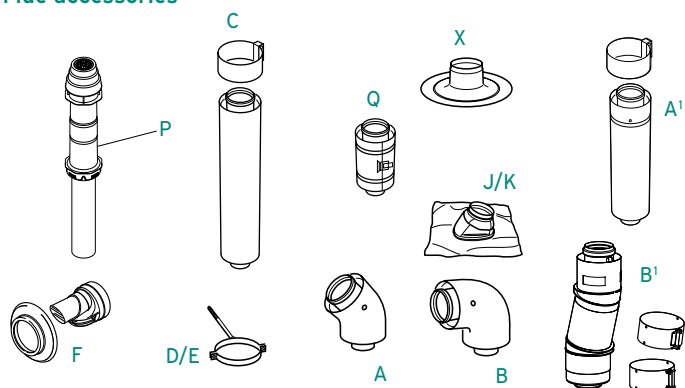

Variable termination kits (not for 80/125 flues or ecoTEC 48/64 boilers, not compatible with 303933 simple flue terminal)

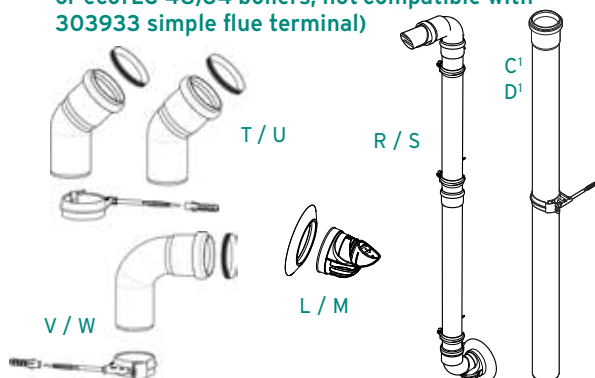

Horizontal flue configuration examples

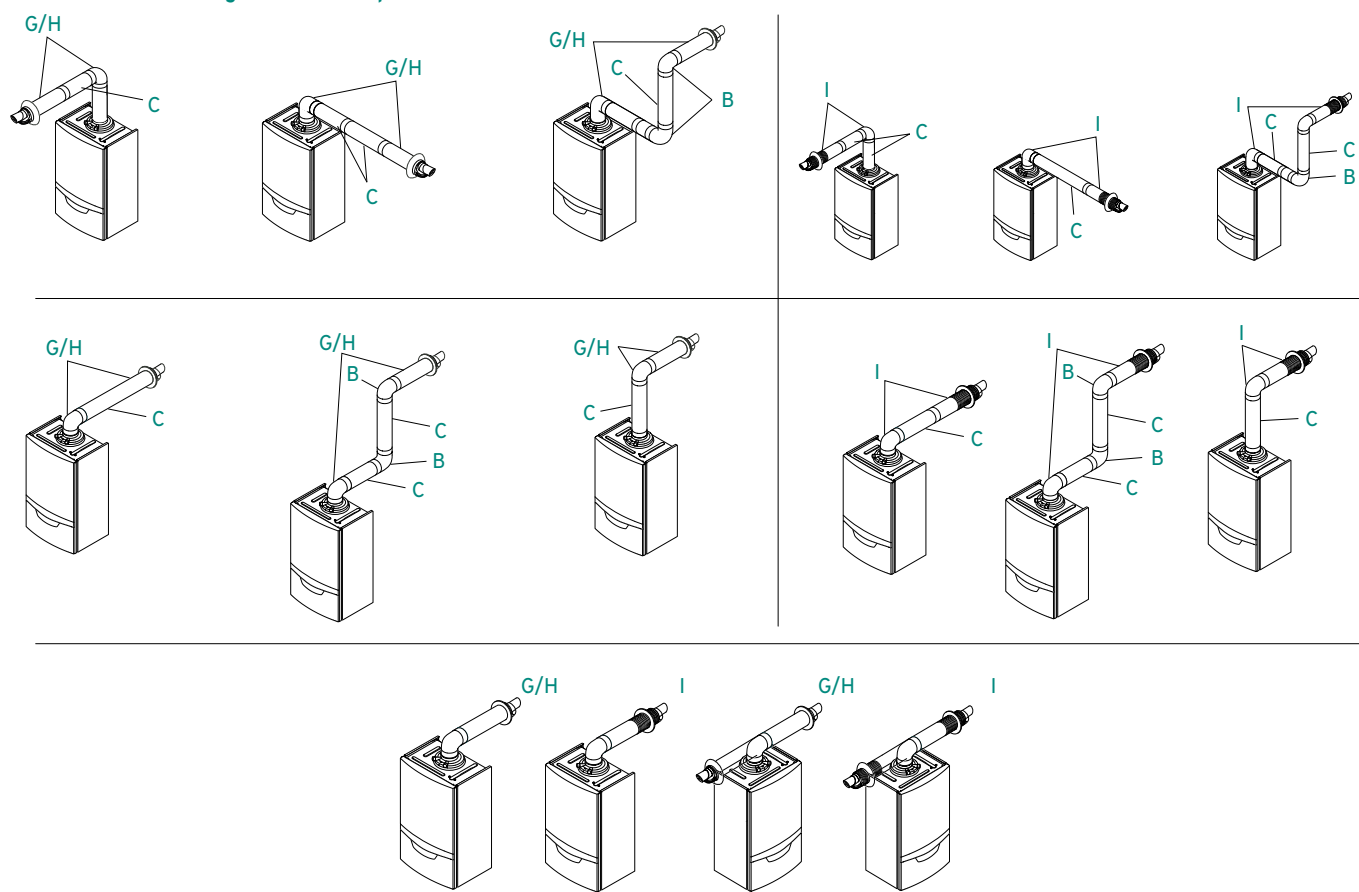

Vertical flue configuration examples

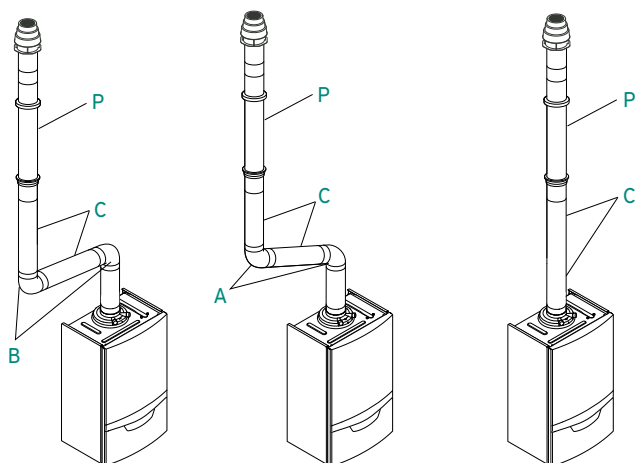

Rear flue configuration (ecoFIT pure and ecoTEC plus open vent only)

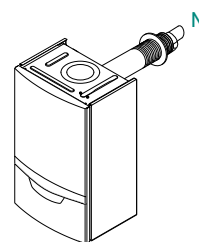

60/100 and 80/125 DN flue components

Component	Description	Part number	
		60/100 DN	80/125 DN
	Diameter	60/100 DN	80/125 DN
A	Bends 45° (pack of 2)	303911	303211
B	Elbow 87°	303910	303210
C	Extension 0.5 m DN60/100	303902	303202
	Extension 1.0m DN60/100	303903	303203
	Extension 2.0m DN60/100	303905	303205
	Extension 4.0m DN60/100	0020138174	-
D	Fixing clamp (140mm thread length) (pack of 5) DN60/100	303821	303616
E	Flue support clips (250mm thread length) (pack of 3) DN60/100	303935	-
F	Flue terminal kit (black)	0020219537	-
G	Horizontal flue kit 1.7m	0020219519	-
H	Horizontal flue kit 0.7m (Comprehensive range)	0020219517	303209
	Horizontal flue kit 0.7m (Simple range)	303933	-
I	Horizontal telescopic flue kit for top exit point	0020219518	-
J	Pitched roof tile flexible (black) 25 to 45°	303980	
K	Pitched weather collar 25 to 50°	009076	
L	Plume deflector kit (black) (not for ecoTEC exclusive)	0020219533	-
M	Plume deflector kit (white) (not for ecoTEC exclusive)	0020219534	-
N	Rear exit telescopic flue kit	0020228140	-
P	Roof terminal (black)	0020223472	303200
Q	Sliding sleeve	303915	303215
R	Variable termination kit (black)	0020219529	-
S	Variable termination kit (white)	0020219530	-
T	Variable termination kit elbow 45° (pack of 2) - (black)	0020219551	-
U	Variable termination kit elbow 45° (pack of 2) - (white)	0020219552	-
V	Variable termination kit elbow 87° (black)	0020219543	-
W	Variable termination kit elbow 87° (white)	0020219544	-
X	Flat roof weather collar	009056	
A ¹	Telescopic flue extension (500 - 800mm)	303906	
B ¹	Telescopic offset flue DN60/100	303919	
C ¹	Variable termination kit extension 1.0m black	0020219539	
D ¹	Variable termination kit extension 1.0m white	0020219540	

Stainless steel 80/125mm facade flue

Maximum facade flue length

ecoTEC plus	48kW	64kW
Maximum permissible length of concentric flue gas pipe	22.0m (includes 3 x 87° elbows and support elbow)	22.0m (includes 3 x 87° elbows and support elbow)

Air intake piece must be positioned no further than 4m from the connection with the boiler.



80/125mm concentric stainless steel facade flue.

Key	80/125mm facade flue	Article number	Key	Facade basic connection set	Article number
A	45° elbow (pack of 2)*	0020042757	1	87° elbow	0020042748
B	87° elbow (pack of 1)*	0020042756	2	Transition piece	
C	Fixing bracket extension	0020042752	3	Inner wall rosette	
D	Rain collar	0020042760	4	Outer wall rosette	
E	1.0m extension	0020042754	5	Wall penetration elbow	
	0.5m extension	0020042753	6	Air intake piece	
	0.5m adjustable extension	0020042755	7	Bird guard terminal	
F	Fixing bracket	0020042751			
G	Fixing bracket	0020042751			
H	Adjustable wall support for heights over 4m	0020042749			

* Can be used to terminate horizontally.

Boiler Protection Kit

Magnetic system filters



Overview

Today's highly energy-efficient heating systems can only offer optimal performance with dirt-free water.

The unique magnetic field booster technology guarantees unprecedented fast, optimal dirt separation. Even the smallest magnetite particles are removed, maximising system performance as well as protecting costly system components.

Thanks to the ingenious design, collected dirt can be removed quickly and easily.

Features & benefits



Small particle removal

Very small particles, from $5\mu\text{m}$ (= 0.005 mm) and up are separated and removed.



Flexible

22mm and 28mm connection diameters available. 22 mm version suitable for boilers with heating output up to 27kW. 28 mm version suitable for boilers with heating output of 28 to 45kW.



Valveless design

No shut-off valves or bypass required.



Instant operation

Instant operation as soon as the system is up and running.



Constant low pressure drop

Maximising system performance.



Extended guarantee

Provides extended guarantees on all Vaillant boiler installations, when registered on Advance. Visit Advance for more information.



Low maintenance

Maintenance only takes a few seconds and is not a dirty job compared to a filter solution.

Advance Boiler Protection Kit

Magnetic system filters



Overview

Correct water quality and treatment is of paramount importance to a healthy heating system. Complete with a 10-year guarantee and manufactured to our very own specification, the Advance Boiler Protection Kit uses a 12,000-gauss magnet to provide strong magnetite removal capabilities. Available as a 22mm variant, the filter fits horizontally onto the pipework, meaning it can be fitted into tighter spaces, and is designed to be fitted close to the bottom of the boiler, making it a more discreet solution.

Due to the magnet utilising an existing boiler isolation valve and the low volume of the magnet, the drain off is shorter, meaning less water drainage when removing magnetite out of the filter. Patent pending UK 2009327.4

Features & benefits



Horizontal fitting with compact design

The filter is designed to be sited horizontally, which saves space so that when fitted, a smaller portion of the filter is visible, allowing more flexible and less intrusive siting options.



Brass design

The main body of the filter is high quality brass to match the standard of the rest of the Vaillant portfolio.



Quick servicing

The filter is easily dismantled at the middle, and the magnet sheath removed, for faster removal of dirt. O-rings for the filter are available as a spare part should any need replacing during the servicing process.



Full 360-degree rotatable head

The rotatable head provides ease of access to the dosing point available underneath the filter.



Compatible with water and water/glycol mixes

Perfect for boilers installed in cold situations where glycol has been added to protect from freezing.



Advanced magnetizing process

Exerts its magnetic power in a wider region, even when full, for fully optimised filtration efficiency that averages over 80%, even when the magnet is fully covered.



Standard 3/4" drain point connection

Can connect to a standard hose, so the drain point can also be used for dosing. The unique sealing ring and swivel head allows it to rotate without leaking for easier serviceability.



Maximum operating temperature 90°C

Ideal for modern systems as well as older, high temperature systems.

Domestic hot water cylinders



Overview

Performance and reliability is what Vaillant is all about. That's why our products have been expertly designed and engineered to work to their full potential together. Working in harmony with all Vaillant domestic boilers, the uniSTOR cylinder range uses state of the art insulation that provides ultimate efficiency. However our high recovery cylinders, with the larger coils, have the advantage of improving boiler output, and reducing heat up times, as well as being designed to work with Vaillant heat pumps.

The high-quality, stainless steel uniSTOR cylinder range is ideal for domestic properties with a new or existing sealed system or open vent boiler. uniSTOR cylinders are 'unvented' cylinders which means they can operate efficiently under higher pressures.

The Vaillant cylinder range meets the appropriate standards, and building and water regulations of the Hot Water Association charter, and is subject to rigorous auditing processes that ensure the highest quality standards are maintained.

Features & benefits



Slimline, pre-plumbed, standard and high recovery cylinders in the range

Slimline for narrow spaces, pre-plumbed for ease of installation, saving onsite time and cost.



Improved insulation

Best in class ErP rating and very low heat loss, meaning lower running costs.



Controls mounting plate

For easy location of controls (pre-plumbed only).



In-line front connections with hidden cable duct

In-line front facing connections for easy access, and hidden cable duct to protect unsightly wiring.



Adjustable feet (excluding slimline models)

For easy installation on uneven ground.



Unvented kit and expansion vessel supplied with product

No additional cost to meet G3 requirements.



25-year guarantee

2-year guarantee on the parts and labour plus 25-year guarantee for the cylinder shell, giving you total peace of mind.



Flexible and a retro-fit solution

Can be upgraded in place of older models, as part of an system upgrade, or future proof your home by installing a high recovery renewable cylinder.

uniSTOR slim-line pre-plumbed cylinder



Technical data	Unit of measure	uniSTOR slimline pre-plumbed	
Model		120	150
Article number		0010019209	0010019210
Maximum height	mm	1452	1667
Diameter	mm	435	435
Unvented kit	l	12	12
Energy-related Products	band	C	C
Heat loss	kW / 24hrs	1.68	1.80
Coil output	kW	16.4	16.1
Coil size	m ²	0.65	0.65
Primary flow rate	l/h	900	900
Re-heat (70%)	mins	15.2	18.4
Heat up 15 to 60°C	mins	21.7	26.3
Actual water capacity	l	121	141
Weight empty	kg	49.5	53.6
Weight full	kg	174	198

uniSTOR slim-line pre-plumbed cylinder

High recovery



Technical data	Unit of measure	uniSTOR slimline pre-plumbed (high recovery)
Model		150
Article number		0020237129
Maximum height	mm	1642
Diameter	mm	435
Unvented kit	l	12
Energy-related Products	band	C
Heat loss	kW / 24hrs	1.80
Coil output	kW	21.7
Coil size	m ²	1.0
Primary flow rate	l/h	900
Re-heat (70%)	mins	12.9
Heat up 15 to 60°C	mins	18.49
Actual water capacity	l	145.1
Weight empty	kg	54.5
Weight full	kg	193.9

uniSTOR pre-plumbed cylinder



Technical data	Unit of measure	uniSTOR pre-plumbed			
Model		180	200	250	300
Article number		0010019211	0010019212	0010019213	0010019214
Maximum height	mm	1169	1269	1539	1749
Diameter	mm	595	595	595	595
Unvented kit	l	18	18	25	25
Energy-related Products	band	B	B	B	B
Heat loss	kW / 24hrs	1.11	1.22	1.41	1.59
Coil output	kW	17.1	16.9	16.6	16.5
Coil size	m ²	0.80	0.80	0.80	0.80
Primary flow rate	l/h	900	900	900	900
Re-heat (70%)	mins	20.7	22.1	30.3	34.0
Heat up 15 to 60°C	mins	29.6	31.6	43.3	48.5
Actual water capacity	l	175	194	245	284
Weight empty	kg	59.0	61.2	70.9	76.0
Weight full	kg	234	255	316	365

uniSTOR pre-plumbed cylinder

High recovery



Technical data	Unit of measure	uniSTOR pre-plumbed (high recovery)		
Model		200	250	300
Article number		0020237130	0020237131	0020237132
Maximum height	mm	1265	1535	1745
Diameter	mm	595	595	595
Unvented kit	l	18	25	25
Energy-related Products	band	B	B	B
Heat loss	kW / 24hrs	1.2	1.4	1.6
Coil output	kW	26.0	40.7	52.5
Coil size	m ²	1.4	2.4	2.8
Primary flow rate	l/h	900	900	900
Re-heat (70%)	mins	14.2	10.6	7.5
Heat up 15 to 60°C	mins	20.83	15.08	10.66
Actual water capacity	l	190.7	236.3	273.5
Weight empty	kg	58.0	73.3	80.6
Weight full	kg	249.4	313.6	369.4

uniSTOR standard cylinder



Technical data	Unit of measure	uniSTOR standard					
		120	150	180	200	250	300
Model		120	150	180	200	250	300
Article number		0020235265	0020235266	0020235267	0020235268	0020235269	0020235270
Maximum height	mm	840	1000	1165	1265	1535	1745
Diameter	mm	595	595	595	595	595	595
Unvented kit	l	12	12	18	18	25	25
Energy-related Products	band	A	A	B	B	B	B
Heat loss	kW / 24hrs	0.83	0.86	1.11	1.22	1.41	1.59
Coil output	kW	15.8	17.2	17.1	16.9	16.6	16.5
Coil size	m ²	0.65	0.65	0.80	0.80	0.80	0.80
Primary flow rate	l/h	900	900	900	900	900	900
Re-heat (70%)	mins	14.3	18.6	20.7	22.1	30.3	34.0
Heat up 15 to 60°C	mins	20.4	26.6	29.6	31.6	43.3	48.5
Actual water capacity	l	115	145	176	194	245	284
Weight empty	kg	30.0	35.0	39.0	42.0	48.0	54.0
Weight full	kg	149	184	219	240	297	343

uniSTOR standard cylinder

High recovery



Technical data	Unit of measure	uniSTOR standard (high recovery)			
Model		150	200	250	300
Article number		0020235271	0020235272	0020235273	0020235274
Maximum height	mm	975	1265	1535	1745
Diameter	mm	595	595	595	595
Unvented kit	l	12	18	25	25
Energy-related Products	band	B	B	B	B
Heat loss	kW / 24hrs	1.0	1.2	1.4	1.6
Coil output	kW	20.8	26.0	40.7	52.5
Coil size	m ²	1.0	1.4	2.4	2.8
Primary flow rate	l/h	900	900	900	900
Re-heat (70%)	mins	13.8	14.6	10.6	7.5
Heat up 15 to 60°C	mins	19.67	20.83	15.08	10.66
Actual water capacity	l	127	172.5	211.0	230.9
Weight empty	kg	38.0	46.0	61.0	67.6
Weight full	kg	181.3	237.4	301.3	356.8

Industry leading training for industry leading engineers



Training

At Vaillant, we pride ourselves on being at the forefront of technology and sharing our expertise. That's why, we offer a wide range of training courses to help support our installers and their businesses. Whether you're looking for online, practical or accredited courses, we can help find the right training journey for you.

Why train with us?



Nationwide training facilities

We have 8 training facilities across the UK, all of which are equipped with industry-leading products to support your learning.



341 years of expertise

The training team have hundreds of years combined expertise between them, so you can rest assured that you're learning from the best in the business.



Hands-on learning

We strive to deliver a practical approach to training, with live boilers and heat pump installations for you to work on at every one of our centres of excellence.



Courses for all skill levels

We provide training for all skill levels, from apprentices right through to experienced engineers.



Loyalty rewards

Earn Advance rewards such as cashback, credits and exclusive invites to events when you train with us.



Ongoing support

Our training team are committed to sharing knowledge, experience and content to support you throughout your Vaillant training journey.

Scan to learn more about our training courses



Service and spares support



Spares and support, year after year

Vaillant is committed to responsible spares provision and provides spares for a minimum of 15 years after production ceases. We have a nationwide network of genuine spares stockists and a dedicated spare parts team to help you identify the parts you require.

Vaillant has even developed an app that helps identify spare parts to make ordering easier. Simply search for Vaillant on Google Play or the App Store.

Service you can count on

At Vaillant UK, we invest as much of our resources into our service and support as we do in creating our outstanding heating solutions. So you can rest assured that when you choose a Vaillant product, you will be supported by the best service in the industry. Vaillant has specialist teams available to support installers and end-users with all enquiries. We pride ourselves on the efficiency of our service departments, supported by online tools that allow our customers to book appointments for our services for added convenience.

Vaillant has over 250 service engineers. This includes the largest specialist fleet of renewable and commercial systems engineers in the UK. With phone operators available 364 days a year, service and support from Vaillant UK is never far away.

Order numbers

Article description	Article number
Advance Boiler Protection Kit (22mm)	0010035819
Boiler Protection Kit (22mm)	0020278309
Boiler Protection Kit (28mm)	0020278310
Combination boilers	
ecoTEC exclusive 835	0010017064
ecoTEC exclusive 843	0010017065
ecoTEC plus 826	0010036015
ecoTEC plus 832	0010036016
ecoTEC plus 836	0010036017
ecoTEC plus 840	0010036018
ecoTEC plus 940	0010036114
ecoTEC pro 24	0010021836
ecoTEC pro 28	0010021837
ecoTEC pro 28 LPG	0010021838
ecoTEC pro 30	0010016538
ecoFIT pure 825	0010020389
ecoFIT pure 830	0010020390
ecoFIT pure 835	0010020391
System boilers	
ecoTEC exclusive 627	0010017063
ecoTEC plus 610	0010036009
ecoTEC plus 615	0010036010
ecoTEC plus 620	0010036011
ecoTEC plus 625	0010036012
ecoTEC plus 630	0010036013
ecoTEC plus 635	0010036014
ecoTEC 48	0010021520
ecoTEC 64	0010021521
ecoFIT pure 612	0010020395
ecoFIT pure 615	0010020396
ecoFIT pure 618	0010020397
ecoFIT pure 625	0010020398
ecoFIT pure 630	0010020399
Open vent boilers	
ecoTEC plus 412	0010021220
ecoTEC plus 415	0010021221
ecoTEC plus 418	0010021222
ecoTEC plus 424	0010021223
ecoTEC plus 424 LPG	0020231355
ecoTEC plus 430	0010021224
ecoTEC plus 435	0010015674
ecoFIT pure 412	0010020400
ecoFIT pure 415	0010020401
ecoFIT pure 418	0010020402
ecoFIT pure 425	0010020403
ecoFIT pure 430	0010020404
ecoFIT pure 435	0010020405
Controls	
vSMART combi pack	0020223154
vSMART system/open vent pack	0020223158

Article description	Article number
VRT 350	0020124475
VRT 350F	0020124482
VRT 15	306777
VR 66/2	0020135785
VR 70	0020184844
VR 71	0020184847
sensoROOM	0010035748
sensoROOM pure	0010038663
timeSWITCH 150	0020116882
timeSWITCH 160	0020124498
Wireless VRC 700F	0020259829
Wired VRC 700	0020236291
myVAILLANT connect	0010037346
myVAILLANT connect + sensoROOM	0010038369
myVAILLANT connect + sensoHOME RF	0010038370
myVAILLANT Connect with VRA 42	0010038367
VRA 42	0010040289
VR 52	020253437
Long eBUS and DC wiring harness	0010035754
H bracket	0010048535
sensoHOME	0010036820
sensoHOME RF	0020260961
sensoCOMFORT	0010036819
sensoCOMFORT RF	0010036820
Cylinders	
Slim-line pre-plumbed	
uniSTOR 120	0010019209
uniSTOR 150	0010019210
uniSTOR 150 (high recovery)	0020237129
Pre-plumbed	
uniSTOR 180	0010019211
uniSTOR 200	0010019212
uniSTOR 250	0010019213
uniSTOR 300	0010019214
uniSTOR 200 (high recovery)	0020237130
uniSTOR 250 (high recovery)	0020237131
uniSTOR 300 (high recovery)	0020237132
Standard	
uniSTOR 120	0020235265
uniSTOR 150	0020235266
uniSTOR 180	0020235267
uniSTOR 200	0020235268
uniSTOR 250	0020235269
uniSTOR 300	0020235270
uniSTOR 150 (high recovery)	0020235271
uniSTOR 200 (high recovery)	0020235272
uniSTOR 250 (high recovery)	0020235273
uniSTOR 300 (high recovery)	0020235274

Article description	Article number
Flues and accessories	
Bends 45° (2 off) DN60/100	303911
Elbow 87° DN60/100	303910
Extension 1.0m DN60/100	303903
Extension 2.0m DN60/100	303905
Extension 4.0m DN60/100	0020138174
Extension 0.5m DN 60/100	303902
Extension 0.5m DN 80/125	303202
Fixing clamp (5 off)	303821
Flue support clips (5 off)	303935
Flue terminal kit (black)	0020219537
Horizontal flue kit 1.7m	0020219519
Horizontal flue kit DN60/100	0020219517
Horizontal telescopic flue kit DN60/100	0020219518
Pitched roof tile flexible	303980
Pitched weather collar	009076
Plume deflector kit (black)	0020219533
Plume deflector kit (white)	0020219534
Pipe cover plate (large)	0020237908
Pipe cover plate (small)	0020237909
Rear telescopic flue kit	0020228140
Roof terminal (black)	0020223472
Ridge tile terminal	303982
Sliding sleeve DN60/100	303915
Telescopic offset flue DN60/100	303919
Variable termination kit (black)	0020219529
Variable termination kit (white)	0020219530
VTK elbow 45 deg (2 off) (black)	0020219551
VTK elbow 45 deg (2 off) (white)	0020219552
VTK elbow 87 deg (black)	0020219543
VTK elbow 87 deg (white)	0020219544
VTK extension 1.0m black	0020219539
VTK extension 1.0m white	0020219540
Spacing frame (ecoFIT pure c&s only)	0020229924
Spacing frame (ecoTEC plus / pro c&s only)	308650
ecoLEVEL condensate pump	0020030797
Upward piping kit	0020237907

Contacts

Sales enquires

Vaillant sells its products through plumbing and heating merchants in the UK. For further information, contact your local Vaillant sales representative.

Phone: **0345 602 0262**

Training

For information on training centres and courses in your area.

Phone: **0345 601 8885**

Email: training@vaillant.co.uk

Technical enquiries

If you have a technical query, you can contact us by phone or email.

Phone: **0344 693 3133**

Email: technical@vaillant.co.uk

Advance support line

There's a Regional Business Manager near you to support your business, along with dedicated Advance support lines.

Call us: **0330 678 0878** or



Email us: advance-support@vaillant.co.uk

General enquiries

If you are unsure of who you need to speak to or you have a general enquiry, our friendly reception staff will happily point you in the right direction.

Phone: **0345 602 2922**



 Heating  Hot water  Renewables

Vaillant Group UK Ltd.

Nottingham Road, Belper, Derbyshire DE56 1JT

Telephone 0345 602 2922

professional.vaillant.co.uk

info@vaillant.co.uk

Search for VaillantUK on 