

For the owner

Operating manual
geoTHERM



Heat pump

VWS

Contents

General information.....	3	5.10 Troubleshooting and diagnosis	24
Data badge	3	5.10.1 Error messages on the controller.....	24
1 Notes on this manual	3	5.10.2 Activating emergency mode	25
1.1 Storage of the documents.....	3	5.10.3 Errors/malfunctions that you can remedy....	25
1.2 Symbols used	4	5.10.4 Warning messages.....	25
1.3 Applicability of the manual.....	4	5.10.5 Temporary malfunctions.....	25
2 Safety instructions	4	5.10.6 Blocking error	26
2.1 Coolants.....	4	6 Warranty and customer service	27
2.2 Prohibition on alterations	5	7 Appendix	28
3 Notes on operation	5	7.1 Technical data.....	28
3.1 Intended use.....	5	7.2 Data badge.....	30
3.2 Requirements of the installation site	6		
3.3 Cleaning and care	6		
3.4 Checking the operational condition of the heat pump.....	6		
3.4.1 Filling pressure of the heating system.....	6		
3.4.2 Filling level and filling pressure of the brine circuit	6		
3.4.3 Accumulation of condensate (condensation water)	7		
3.5 Energy saving tips	7		
3.5.1 General energy saving tips.....	7		
3.5.2 Economising by the correct use of the control system.....	7		
3.6 Recycling and disposal	8		
3.6.1 Appliance.....	8		
3.6.2 Packaging.....	8		
3.6.3 Coolants.....	8		
4 Equipment and functional description	9		
4.1 Functional principle	9		
4.2 Operation mode of the coolant circuit	9		
4.3 Automatic auxiliary functions.....	10		
4.4 Design of the geoTHERM heat pump.....	11		
5 Operation	12		
5.1 Familiarising yourself with and operating the controller	12		
5.2 Setting menus and parameters.....	13		
5.3 Description of the controller	13		
5.3.1 Possible system circuits	13		
5.3.2 Energy balance controller	14		
5.3.3 Charging principle buffer cylinder.....	14		
5.3.4 Resetting to factory settings.....	14		
5.3.5 Controller structure	14		
5.3.6 Setting energy saving functions	14		
5.4 Flow diagram.....	15		
5.5 Displays in the user level	16		
5.6 Installer Menu	22		
5.7 Starting up the heat pump	24		
5.8 Shutting down the heat pump	24		
5.9 Inspection.....	24		

General information

The Vaillant geoTHERM heat pumps in this manual are referred to in general as heat pumps and are available in the following models:

Type name	Article number
VWS 61/2 230 V	0010005501
VWS 81/2 230 V	0010005502
VWS 101/2 230 V	0010005503

Table 0.1 Type designations and article numbers



The heat pumps state-of-the-art appliances which have been constructed in accordance with recognised safety regulations.

Conformity with the applicable standards has been demonstrated.



'DACH' seal of approval



VDE seal and Tested Safety

With the CE mark, we confirm as equipment manufacturers that the appliances in the geoTHERM range satisfy the requirements of the Directive on Electromagnetic Compatibility (Council Directive 89/336/EC). The appliances meet the basic requirements of the Low Voltage Directive (Council Directive 73/23/EEC).

Furthermore, the appliances satisfy the requirements of EN 14511 (Heat pumps with electrically-driven compressors, heating, specifications for appliances for space heating and for warming drinking water) as well as EN 378 (safety and environmentally related specifications for refrigerating systems and heat pumps).

Data badge

An identification plate is attached to the baseplate on the inside of the geoTHERM heat pump. The type designation is located at the top on the grey frame of the pillar (see also Fig. 4.3, Item 1). In Chapter 7.2 of the Appendix there is a picture of an identification plate for the benefit of technically-interested customers, and a table explaining the symbols shown on it.

1 Notes on this manual

The following information is intended to help you throughout the entire documentation. Further documents apply in combination with this operating manual. We accept no liability for any damage caused by failure to observe these instructions.

Other applicable documents for the expert technician: Installation instructions No. 838408 as well as all the accessories instructions listed therein

The following information is intended to help you throughout the entire documentation. Further documents apply in combination with this operating manual. **We accept no liability for any damage caused by failure to observe these instructions.**

Other applicable documents

For the owner of the system:

Warranty card No. 802922

For the heating engineer:

geoTHERM installation instructions No. 0020046310

Other applicable documents are all the manuals that describe the operation of the heat pump, as well as other manuals for all the accessories used.

1.1 Storage of the documents

Please store this operating manual and all related documents in such a way that they are available whenever required.

You can store the documents inside the pillar cover.

1 Notes on this manual

2 Safety instructions

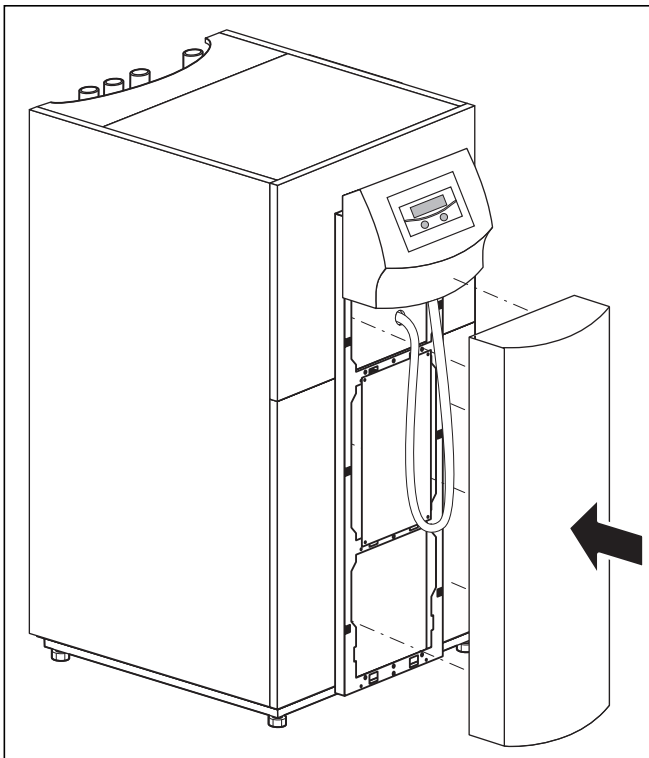

Fig. 1.1 Removing the pillar cover

1.2 Symbols used

The following hazard classification symbols are used for information, activities and energy saving tips in this operating manual.



Danger!
Immediate risk of serious injury or death



Danger!
Danger of burning and scalding!



Caution!
Potentially dangerous situation for the product and environment.



Note!
Useful information and instructions.



This symbol points you to energy saving tips. You can put this setting into effect by means of the heat pump control system, among other things.

- Symbol for a necessary task

1.3 Applicability of the manual

This operating manual applies exclusively to units with the following article numbers:

0010005501
0010005502
0010005503

The part number of your unit can be obtained from the identification plate.

2 Safety instructions

Observe the following safety instructions and regulations when operating the heat pump:

- Take advantage of the extensive instruction in the operation of the heat pump provided by your specialist technician.
- Carefully read through this operating manual.
- Only carry out activities that are described in this operating manual.



Danger!
Risk of burning as a result of contact with heat pump components!
High temperatures can appear on heat pump components.
Do not touch any uninsulated pipes on the heat pump.
Do not remove any of the cladding sections (apart from the pillar cover, see Ch. 1.1).

2.1 Coolants

The heat pump is delivered with an operational filling of R 407 C coolant. This is a chlorine-free coolant which does not affect the Earth's ozone layer. R 407 C is neither a fire hazard nor an explosion risk.



Caution!
This appliance contains R 407 C coolant. The coolant must not be allowed to escape into the atmosphere. R 407 C is a fluorinated greenhouse gas covered by the Kyoto Protocol, with a GWP of 1653 (GWP = Global Warming Potential).
Before the appliance is disposed of, the coolant it contains must be completely drained into a suitable vessel so that it can then be recycled or disposed of in accordance with the regulations.



Danger!
Risk of injury from freezing as a result of contact with the R 407 C coolant! Escaping coolant can cause freezing if the exit point is touched: Do not inhale gases or vapours emanating from leaks in the coolant circuit. Avoid contact with the skin and eyes.



Note!
R 407 C presents no danger in normal use and under normal conditions. With improper use, however, it can cause injury and damage.

2.2 Prohibition on alterations



Danger!
Inappropriate alterations can cause injuries!
Under no circumstances should you attempt to make changes or alterations to the heat pump or other parts of the heating and hot water system yourself.

The prohibition applies to:

- the geoTHERM heat pumps,
- the vicinity of the geoTHERM heat pumps,
- the supply lines for water and power.

For alterations to the heat pump or its peripherals, you must call on a qualified engineer.

- Do not damage or remove seals or locking devices on components. Only suitably qualified heating engineer or our customer service may remove sealed components.

3 Notes on operation

The Vaillant geoTHERM heat pumps are state-of-the-art appliances which have been constructed in accordance with recognised safety regulations and must be installed by a qualified expert technician in compliance with the existing regulations, rules and directives.



Danger!
Risk to life as a consequence of using unqualified personnel!
Installation, inspection and repair may only be carried out by a qualified engineer. In particular, working on the electrical components and on the coolant circuit requires an appropriate qualification.

3.1 Intended use

The Vaillant heat pumps are built and designed according to accepted safety rules and regulations. Nevertheless, there is still a risk of injury or death to the user or others or of damage to the device and other property in the event of improper use or use for which it is not intended.

This unit is not intended for use by persons (including children) having limited physical, sensory or mental capacities or who have inadequate experience and/or knowledge, unless they are supervised by a person responsible for their safety or have been given instructions by him regarding the operation of the unit.

Children must be supervised to ensure that they do not play with the unit.

The units are intended as heat generators for closed hot-water central heating installations and for hot water preparation. Any other use or extended use is considered to be improper. The manufacturer or supplier is not liable for any resulting damage. The user alone bears the risk.

It is also considered as intended use to observe:

- the operating and installation instructions
- all other applicable documents
- adherence to the inspection and care conditions.

3 Notes on operation



Danger!
Risk to life as a consequence of improper use of the installation.
There is a risk of death or serious injury to the user or third parties or of damage to the device and other property in the event of improper use or use for which it is not intended.

3.2 Requirements of the installation site

The installation site must be dimensioned such that the heat pump can be properly installed and maintained.

- Ask your heating engineer which currently applicable national building regulations must be observed.

The installation site must be dry and generally frost-proof.

3.3 Cleaning and care

Do not use any scouring or cleaning agents that could damage the cladding.



Note!
Clean the exterior of your heat pump with a damp cloth and a little soap.

3.4 Checking the operational condition of the heat pump

In contrast to heaters based on fossil fuels, no expensive maintenance work is necessary for the Vaillant geoTHERM heat pump.



Note!
Have your installation checked regularly by an expert technician company to ensure efficient operation of your heat pump.

3.4.1 Filling pressure of the heating system

The filling pressure of the heating installation should be checked at regular intervals. The filling pressure of the heating installation can be checked from the reading on the heat pump controller (see sect. 5.5). It should be between 1 and 2 bar. If the water pressure falls below 0.5 bar, the heat pump will be shut down automatically and an error message will be displayed.



Caution!
Risk of damage from water escaping from leaks in the system.
Close the cold water stop valve in the event of leaks in the hot water pipework. In the event of leaks in the heating installation switch off the heat pump to avoid any further leaking.
Have the leaks repaired by an expert technician.



Note!
The cold water stop valve is not part of the heat pump scope of supply. It is fitted on site by your heating engineer. He will explain the location and handling of the component to you.

3.4.2 Filling level and filling pressure of the brine circuit

Check the brine level or pressure in the brine circuit at regular intervals. The filling pressure of the brine circuit ("Pressure Heat Source") can be checked from the reading on the heat pump controller (see sect. 5.5). It should be between 1 and 2 bar. If the brine pressure falls below 0.2 bar, the heat pump will be shut down automatically and an error message will be displayed.



Caution!
Risk of damage from brine escaping from leaks in the system.
In the event of leaks in the brine circuit switch off the heat pump to avoid any further leaking.
Have the leaks repaired by an expert technician.



Caution!
The brine circuit must be filled with the correct quantity of fluid; otherwise the system can be damaged.

If the filling level of the brine has fallen so far that it is no longer visible in the expansion tank, you must have the brine refilled.

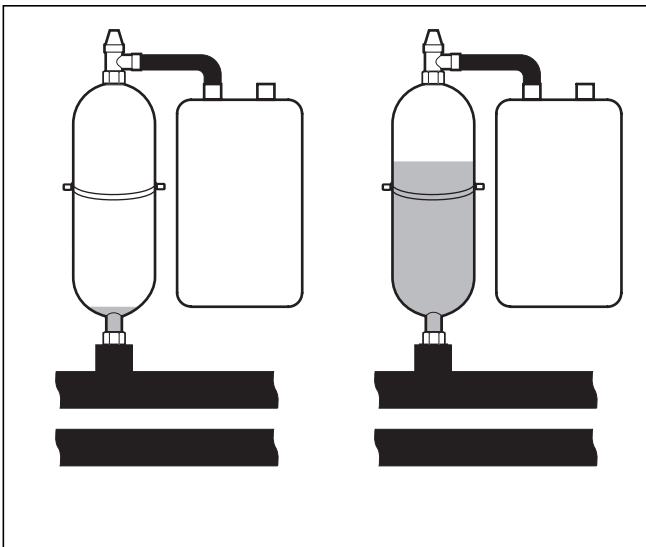

Fig. 3.1 Filling level of the brine expansion tank

It is normal for the filling level of the brine to fall a little in the first month after the start-up of the system. The filling level can also vary depending on the temperature of the heat source. However it should never sink so far that it is no longer visible in the expansion tank.



Caution!
Risk of damage!
The filling of the brine circuit in your heat pump installation may only be undertaken by authorised specialists. Check the filling level of the brine circuit at regular intervals and inform your expert technician company if the filling level in the brine expansion tank is too low.

3.4.3 Accumulation of condensate (condensation water)

The evaporator, the brine pumps and the pipes in the heat source circuit, as well as some components in the coolant circuit, are insulated in the interior of the heat pump, so that no condensate can accumulate. If condensate should ever accumulate in small amounts this will be collected by the condensate basin. The condensate basin is located on the inside, in the lower part of the heat pump. As a result of the heat generated inside the heat pump, the condensate in the condensate pan evaporates. Small amounts of the accumulating condensate can be drained off under the heat pump. In small amounts, accumulating condensate should not be seen as a fault in the heat pump.

3.5 Energy saving tips

Below you will find important tips to help you operate your heat pump system in an energy and cost-saving manner.



3.5.1 General energy saving tips

You can even save energy by your general behaviour:

- Ventilate correctly:
 - Do not leave windows or French windows tilted open, but rather open the windows wide 3 or 4 times a day for 15 minutes and turn down the thermostatic valves or room thermostats while ventilating.
- Do not block the radiators to ensure that heated air can circulate in the room.
- Use a ventilation system with heat recovery.
 - The optimum exchange of air in the building is always guaranteed by the use of a ventilation system with heat recovery (windows no longer need to be opened for ventilation purposes). If necessary, the air flow can be matched to your individual requirements with the ventilation unit's remote control.
- Check that windows and doors are airtight: Keep shutters and blinds closed at night, so that as little heat as possible is lost.
- If a VR 90 remote control unit is installed as an accessory, do not obstruct it with furniture, etc., so that it can measure the circulating room air unhindered.
- Think when using water, for example, take a shower instead of a bath, promptly renew the seals on dripping taps.



3.5.2 Economising by the correct use of the control system

Further economies can be made by the correct use of the control system on your heat pump.

The control of the heat pump helps you to make savings by:

- The correct selection of the heating flow temperature:
 - Your heat pump controls the heating flow temperature depending on the room temperature you have set. Therefore select a room temperature that is just sufficient for your comfort, for example 20 °C. Every degree over and above that means an increase in energy consumption of around 6% per annum.
- For floor heating use heating curves of < 0.4. For radiator heating, we recommend that they are laid out to manage with a maximum flow temperature of 50 °C at the lowest outside temperature; this corresponds to heating curves of < 0.7.
- An appropriate setting of the hot water temperature:
 - Only heat hot water as much as is required for consumption. Any further heating results in unnecessary power consumption, and hot water temperatures of

3 Notes on operation

more than 60°C also lead to increased lime scale production. We recommend that hot water generation be achieved without the electric auxiliary heating; by this method, the maximum hot water temperature is determined by the high pressure cut-out in the heat pump cooling circuit. This cut-out corresponds to a maximum hot water temperature of approx. 58°C.

- Setting of individually suited heating times.
- Select the correct operating mode:
For the times that you are asleep or away, we recommend that you switch the heating to set-back mode.
- Heat uniformly:
By means of a meaningfully constructed heating programme, you can arrange for all the rooms in your house to be uniformly heated in accordance with your pattern of use.
- Set the thermostatic valves:
You can adjust the room temperature to suit your individual requirements and ensure effective operation of your heating installation using the thermostatic valves in combination with a room temperature regulator (weather compensator).
- The operating times of the circulation pump can thus be optimally matched to the actual need.
- Consult a qualified engineer. He will adjust your heating installation to suit your personal requirements.
- You will find these and other energy saving tips in Chap. 5.5. The controller settings that can potentially save energy are described there.

3.6 Recycling and disposal

Both your heat pump and all its accessories and associated transport packaging consist overwhelmingly of raw materials that can be recycled, and thus have no place in your household waste.



Note!
Please observe the applicable national legal regulations.
Make sure the old appliance and any accessories are disposed of properly.



Caution!
Environmental hazard due to improper disposal!
The disposal of coolant must only be by qualified specialists.

3.6.1 Appliance



If your heat pump is identified with this symbol, it does not belong with your household waste at the end of its useful life.

As this heat pump is not covered by the law regarding the marketing, return and environmentally friendly disposal of electrical and electronic equipment (ElektroG in Germany), free disposal at a municipal collection point is not provided.

3.6.2 Packaging

Leave the disposal of the transport packaging to the qualified servicing company which installed the appliance.

3.6.3 Coolants

The Vaillant heat pump is filled with R 407 C coolant.



Danger!

Risk of injury from freezing as a result of contact with the R 407 C coolant!
Escaping coolant can cause freezing if the exit point is touched:
Do not inhale gases or vapours emanating from leaks in the coolant circuit.
Avoid contact with the skin and eyes.
The disposal of coolant must only be by qualified specialists.



Note!

R 407 C presents no danger in normal use and under normal conditions. With improper use, however, it can cause injury and damage.

4 Equipment and functional description

4.1 Functional principle

Heat pump systems consist of separate circuits in which liquids or gases transport the heat from the heat source to the heating system. As these circuits operate with differing media (brine/water, coolant and heating water), they are coupled to one another by means of heat exchangers. In these heat exchangers the heat passes from a medium at a high temperature to a medium at a lower temperature.

The Vaillant geoTHERM heat pump uses geothermal energy as its heat source.

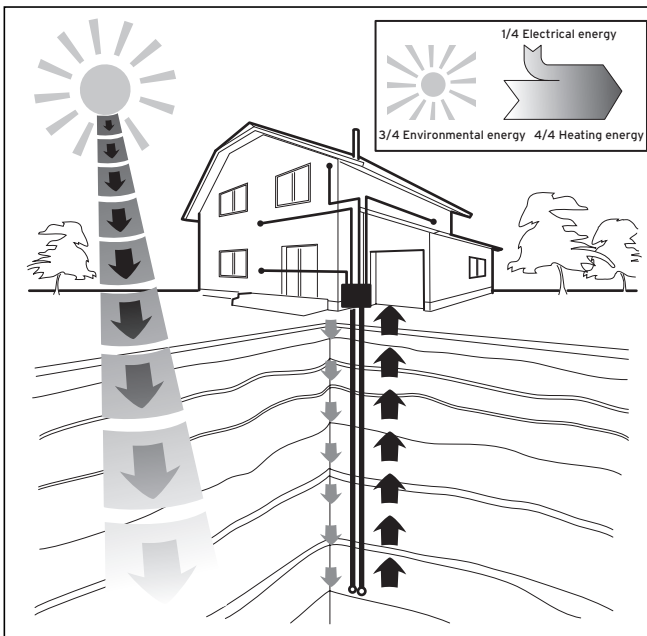

Fig. 4.1 Using a geothermal heat source

The system consists of separate circuits which are coupled with one another by means of heat exchangers. These circuits are:

- The heat source circuit, by means of which the energy from the heat source is transported to the coolant circuit.
- The coolant circuit, which releases its heat to the heating water circuit by means of evaporation, compression, liquefaction and expansion.
- The heating water circuit, which supplies the heating and the hot water generator for the domestic hot water cylinder.

4.2 Operation mode of the coolant circuit

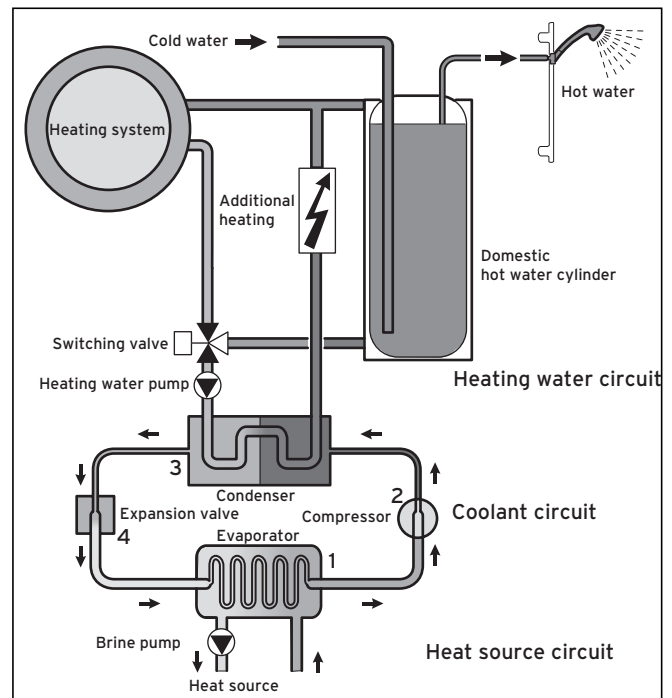

Fig. 4.2 Mode of operation of the heat pump

The coolant circuit is connected by means of the evaporator (1) to the geothermal heat source, from which it extracts thermal energy. At the same time, the physical state of the coolant changes; it evaporates. The coolant circuit is connected by means of the condenser (3) to the heating system, to which it releases the heat again. In so doing, the coolant becomes liquid again; it condenses.

As thermal energy can only pass from a body at a higher temperature to a body at a lower temperature, the coolant in the evaporator must have a lower temperature than the geothermal heat source. On the other hand, the temperature of the coolant in the condenser must be higher than that of the heating water in order to be able to release the heat to it.

These different temperatures are produced in the coolant circuit by means of a compressor (2) and an expansion valve (4), which are situated between the evaporator (1) and the condenser. The coolant flows in vapour form from the evaporator (1) into the compressor, where it is compressed. This causes the pressure and temperature of the coolant vapour to rise sharply. After this process it flows through the condenser, where it releases its heat to the heating water by condensation. It flows as a liquid to the expansion valve, where it expands significantly and in so doing loses much of its pressure and temperature. This temperature is now lower than that of the outside air which flows through the evaporator (1). The coolant can thus take up more heat in the evaporator, (1) turning into vapour in the

4 Equipment and functional description

process and flowing to the compressor. The cycle starts again.

If required, the electric auxiliary heating can be switched in by the integrated controller.

To prevent the formation of condensate in the interior of the unit, the pipes of the heat source circuit and the coolant circuit are insulated. Should condensate appear, however, it is collected in a pan inside the unit and diverted away underneath it. Drop formation under the heat pump is thus possible.

4.3 Automatic auxiliary functions

Frost protection

The controller is equipped with a frost protection function. This function ensures that your heating installation is protected from frost in all operating modes.

If the outside temperature falls below a value of 3 °C, a set-back temperature is automatically programmed for each heating circuit.

Cylinder frost protection

This function starts automatically when the actual temperature of the cylinder falls below 10 °C. The cylinder is then heated to 15 °C. This function is also active in the "Off" and "Auto" operating modes, regardless of the timer programmes.

Checking the external sensors

The hydraulic basic circuit given by you during commissioning determines the required sensors. The heat pump constantly checks automatically that all sensors are installed and functioning.

Protection from loss of heating water

An analogue pressure sensor monitors possible low water pressure and switches the heat pump off if the water pressure on the pressure gauge reads less than 0.5 bar and switches it back on when the water pressure is over 0.7 bar on the pressure gauge.

Pump seizing and valve seizing protection

To prevent the sticking of the heating, circulation and brine pump or of the hot water diverter valve UV1, the pumps and the valve, which have not been in operation for 24 hours, are switched on every day for approx. 20 sec.

Protection against loss of brine

An analogue pressure sensor monitors possible low brine pressure and switches the heat pump off if the brine pressure is ever less than 0.2 bar on the pressure gauge and error 91 is displayed on the error memory. The heat pump switches on again when the brine pressure rises above 0.4 bar gauge pressure.

If the brine pressure drops below 0.6 bar on the pressure gauge for more than one minute a warning appears in menu 1.

Floor protection circuit for all hydraulics without buffer cylinder (e.g. in hydraulic plans 1 and 3)

If the measured flow temperature in the underfloor heating circuit continuously exceeds a value for more than 15 minutes, the heat pump switches off and issues an error message 72. When the heating flow temperature falls below this value again and the error has been reset the heat pump switches back on.



Caution!

Danger of damage to the floor.

Set the value for the floor protection circuit ensuring that it is not high enough to damage the floor as a result of excessively high temperatures.

Phase monitoring

The sequence and existence of phases (clockwise rotating field) on the 400 V voltage supply are continuously monitored during commissioning and operation. If the sequence is not correct or if a phase breaks down, the heat pump is switched off due to the error to avoid damage to the compressor.

Freezing protection function

The outlet temperature of the heat source is constantly measured. If the heat source outlet temperature falls below a specific value, the compressor temporarily shuts off with the error message 20 or 21. If these errors occur three times in a row there is a fault-induced shutdown.

For the geoTHERM VWS heat pumps you can set the value (Default setting -10 °C) for the freezing protection in the installation assistant A4.

4.4 Design of the geoTHERM heat pump

The heat pump is available in the following models. The heat pump are, above all, different from each other in their output.

Type name	Heating output (kW)
VWS 61/2 230 V	6.0
VWS 81/2 230 V	8.1
VWS 101/2 230 V	10.5

Table 4.1 Type summary

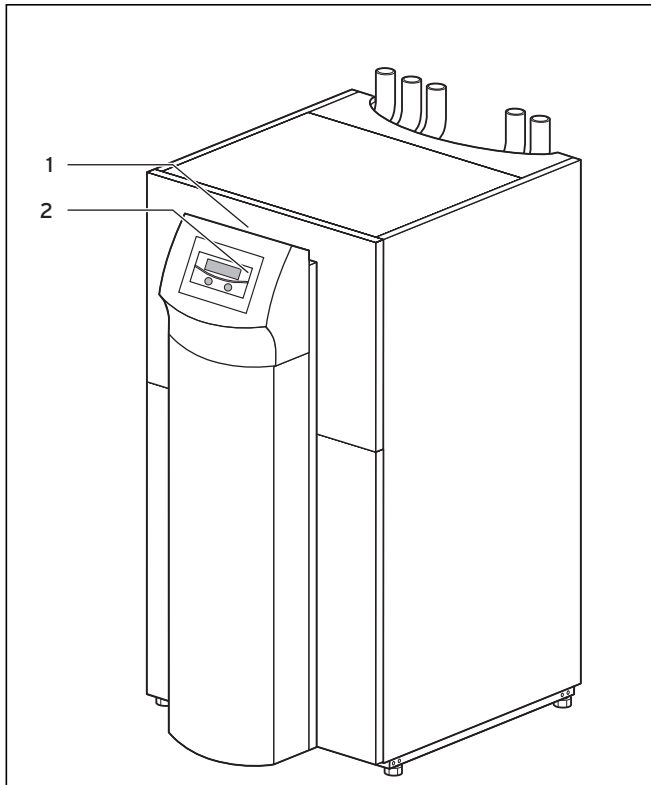

Fig. 4.3 Front view

Key to Fig. 4.3

- 1 Label with heat pump type designation
- 2 Operating panel

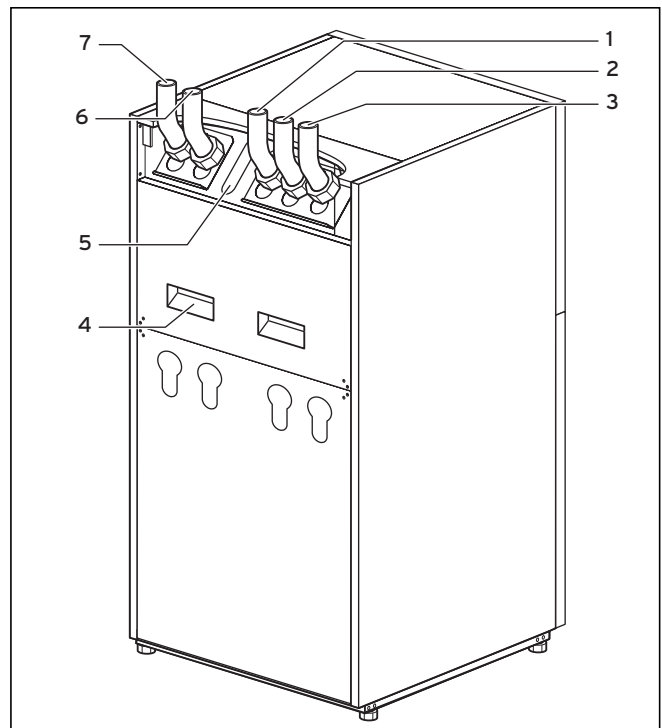

Fig. 4.4 Rear view

Key to Fig. 4.4

- 1 Return to domestic hot water cylinder
- 2 Coolant to heat pump
- 3 Coolant from heat pump
- 4 Transportation handles
- 5 Cable duct for electrical connections
- 6 Heating return
- 7 Heating feed

5 Operation

5.1 Familiarising yourself with and operating the controller

All programming of the heat pump is carried out by means of the two dials (⌚ and ⌚) on the controller. The dial ⌚ is used to select the parameter (by pressing) and to alter the parameter (by turning). The dial ⌚ is used to select the menu (by turning) and to activate special functions (by pressing).

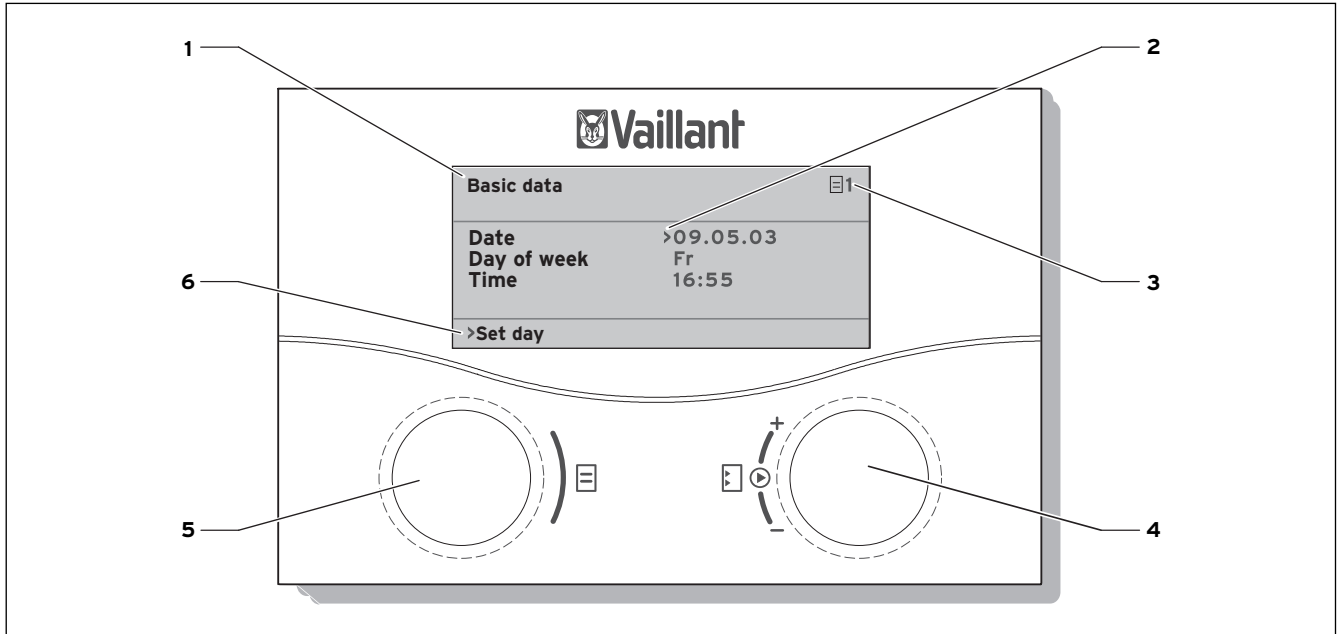

Fig. 5.1 Operating overview















Key

- 1 Menu name
- 2 Cursor indicates the selected parameter
- 3 Menu number
- 4 Dial ⌚, position parameter (turn), select parameter (press)
- 5 Dial ⌚, select menu (turn), activate special operation (press)
- 6 Information line (in the example a handling request)

Typical operating process (operator level)

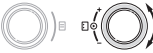
		• Turn the dial ⌚ until the menu required has been selected.
		• Turn the dial ⌚ until the parameter to be modified has been selected.
		• Press the dial ⌚ to mark the parameter to be modified. The parameter background is darkened.
		• Turn the dial ⌚ to modify the parameter setting value.
		• Press the dial ⌚ to mark the setting value to be accepted.

5.2 Setting menus and parameters

setting to date		modified setting						
<p>Holiday programming for cpl. System  6</p> <hr/> <p>Period of time</p> <table border="0"> <tr> <td>1</td> <td>>06.01.08</td> <td>08.01.08</td> </tr> <tr> <td>2</td> <td>14.01.08</td> <td>30.01.08</td> </tr> </table> <p>Room Temp. setpoint 12°C</p> <p>>Set start day</p>	1	>06.01.08	08.01.08	2	14.01.08	30.01.08	<p>Select menu:</p>  <ul style="list-style-type: none"> Turn the  dial: Select menu e.g. from menu 6 to 7. 	<p>Basic data  7</p> <hr/> <p>Date >21.04.08</p> <p>Day of week Mo</p> <p>Time 09:35</p> <hr/> <p>>Set day</p>
1	>06.01.08	08.01.08						
2	14.01.08	30.01.08						
<p>Basic data  7</p> <hr/> <p>Date >21.04.08</p> <p>Day of week Mo</p> <p>Time 09:35</p> <hr/> <p>>Set day</p>	<p>Select parameter:</p>  <ul style="list-style-type: none"> Turn the  dial: select the parameter to be modified e.g. from line 1 day to line 2 weekday (in this example continue to turn 3 snap-in points). 	<p>Basic data  7</p> <hr/> <p>Date 21.04.08</p> <p>Day of week >Mon</p> <p>Time 09:35</p> <hr/> <p>>Set weekday</p>						
<p>Basic data  7</p> <hr/> <p>Date 21.04.08</p> <p>Day of week >Mon</p> <p>Time 09:35</p> <hr/> <p>>Set weekday</p>	<p>Modify parameter weekday from Monday to Tuesday:</p>  <ul style="list-style-type: none"> Push the  dial: Select parameter:  <ul style="list-style-type: none"> Turn the  dial: Modify parameter,  <ul style="list-style-type: none"> Push the  dial: Accept modification. 	<p>Basic data  7</p> <hr/> <p>Date 21.04.08</p> <p>Day of week >Tues</p> <p>Time 09:35</p> <hr/> <p>>Set weekday</p>						

5.3 Description of the controller

The heating engineer will have set all the operating parameters to preset values during commissioning, so that the heat pump can function optimally. However, you can individually set and adapt the operating modes and functions afterwards.

5.3.1 Possible system circuits

The controller can control the following system circuits:

- a heating circuit,
- an indirectly heated hot water storage tank,
- a hot water circulation pump,
- a buffer circuit.

In order to extend the system a buffer circuit can be used to connect up to six additional mixer circuit modules VR 60 (accessories) each with two mixer circuits. The controller on the operating panel of the heat pump is used to programme the mixer circuits.

In order to operate under comfortable conditions you can connect the remote control units VR 90 for the first eight heating circuits.

5 Operation

5.3.2 Energy balance controller

The energy balance controller is only applicable to hydraulics without buffer cylinder.

For economical and fault-free operation of a heat pump, it is important to regiment the starting of the compressor. The start-up of the compressor is the point at which the highest loading occurs. With the help of the energy balance controller it is possible to minimise starts of the heat pump without compromising the comfort of a pleasant room atmosphere.

As with other weather-controlled heating controllers the controller determines a supply set target temperature by capturing the outside temperature through a heating curve. The energy balance calculation is carried out based on this supply set target temperature and the supply real temperature the difference of which is measured per minute and added up:

1 degree minute [°min] = 1K temperature difference in the supply from 1 Minute (K = Kelvin)

The heat pump starts up at a defined heat deficit and only switches off again when the supplied heat is equal to the heat deficit.

The larger the preset negative numerical value is, the longer the periods for which the compressor is kept running or at standstill.

5.3.3 Charging principle buffer cylinder

The buffer cylinder is controlled depending on the supply set target temperature. The heat pump heats when the temperature of the buffer cylinder head temperature sensor VF1 is smaller than the set target temperature. It continues to heat until the buffer cylinder floor temperature sensor RF1 has reached the set target temperature plus 2K.

In the connection to a hot water cylinder charging the buffer cylinder is also charged when the temperature of the head temperature sensor VF1 is less than 2K higher than the set target temperature (premature reheating):
 $VF1 < T_{VL\ set} + 2K$.

5.3.4 Resetting to factory settings



Caution!
Inadvertent deletion of specific settings!
When you reset the control system to the default settings, specific system settings can be deleted and the system can shut down. The system does not suffer damage.

- In the basic display on the graphic display press both dials at the same time for min. 5 sec.

After that you can select whether to reset only the timer programme or all values to the default settings.

5.3.5 Controller structure

The **top-level display** is a **graphics display**. It is the starting point for all the available displays. This display reappears automatically if you do not actuate any of the dials for a long time when setting values.

Controller operation is subdivided into four levels:

The **operator level** is specified for the operator.

In Sect. 5.4 all of the controller's displays are shown as a flow diagram. A detailed description of the displays is contained in Sect. 5.5.

The **code level** (menu C1 - C9, D1 - D5, I1 - I5 and A1 - A9) is reserved for the engineer and protected by a code to protect it from unintentional modification.

As the operator you can scroll through the menus of the code level and view the system-specific setting parameters however without changing the values.

In the menus C1 to C9 the engineer sets system-specific parameters.

The menus D1 to D5 enable the engineer to operate and test the heat pump in the diagnosis mode.

In menus I1 to I5 you are given general information on the settings of the heat pump.

Menus A1 to A9 take the engineer through the installation menu to put the heat pump into operation.

The display and selection of **special function** (e.g. the energy-saving function) is also possible for the operator. Instructions are given in Sect. 5.6 as to how to activate the special functions.

The fourth level contains functions for the optimisation of the system and can only be set by the engineer using **vrDIALOG 810/2**.

5.3.6 Setting energy saving functions

Also described in Chap. 5.5 are heat pump settings that will enable a reduction in your energy costs. This is achieved by optimum setting of the heat pump's weather-controlled energy balance controller.



This symbol points you to these energy saving tips.

5.4 Flow diagram

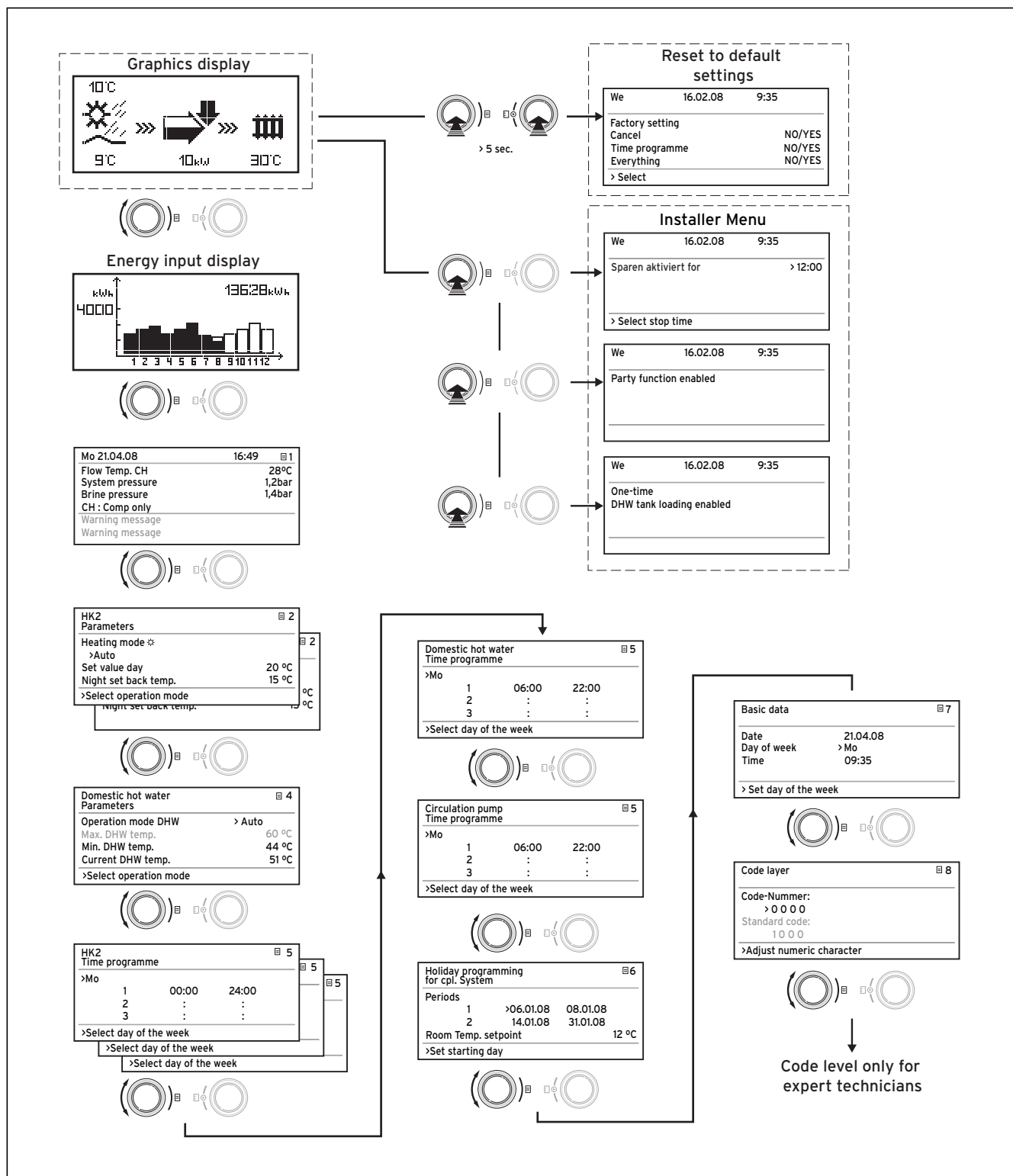

Fig. 5.2 Displays in the User level

5 Operation

5.5 Displays in the user level

The individual menus on the controller are described and explained below.







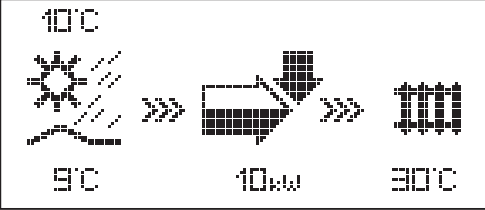

Display shown	Description
	<p>Graphics display (Top-level display) You can read off the instantaneous state of the system from this display. This is always shown if you have not actuated either of the dials for a long time while another display is showing.</p> <p> Outside temperature (here 10 °C).</p> <p> Source inlet temperature: Temperature sensor; in the example 9 °C.</p> <p> Under the arrow the output of the heat source (in the example 10 KW) is displayed. The extent of darkening of the arrow graphically shows the energy efficiency of the heat pump under the given operating conditions.</p> <p>The output of the heat source must not be equated with the heating output. The heating output corresponds to approx. the output of the heat source + compressor output.</p> <p> When the compressor or the electric auxiliary heating is switched on, the arrow is shown filled.</p> <p> >>> Left and right flash when the compressor is switched on and energy is consequently being taken from the environment and fed to the heating system.</p> <p> >>> Right flashes when energy is being fed to the heating system (e.g. only from the electric auxiliary heating).</p> <p> The heat pump is in the CH mode. Moreover, the heating flow temperature is displayed (in the example 30 °C).</p> <p> The symbol indicates that the domestic hot water cylinder is being heated or that the heat pump is in the ready state. The temperature in the domestic hot water cylinder is also displayed.</p>

Table 5.1 Settable parameters in the operator level

Display shown	Description																					
	<p>Energy input display Shows the energy extracted from the environment for each of the 12 months of the current year (black bar). White-filled bars represent the future months of the year; the height of the bar corresponds to the yield for the month in the previous year (comparison possible). On commissioning, the height of the bars is zero for all months, as no information is available yet. The scaling (in the example, 4000 kWh) adapts automatically to the month's highest value. Top right the total of the environmental yield since commissioning is displayed (in the example: 13628 kWh).</p>																					
<table border="1" data-bbox="135 645 630 884"> <tr> <td>Mon. 21.04.08</td> <td>16:49</td> <td>☰ 1</td> </tr> <tr> <td>Current flow temp.</td> <td>28 °C</td> <td></td> </tr> <tr> <td>CH pressure</td> <td>1.2 bar</td> <td></td> </tr> <tr> <td>Brine pressure</td> <td>1.4 bar</td> <td></td> </tr> <tr> <td>Heating only comp.</td> <td></td> <td></td> </tr> <tr> <td>Warning message</td> <td></td> <td></td> </tr> <tr> <td>Warning message</td> <td></td> <td></td> </tr> </table>	Mon. 21.04.08	16:49	☰ 1	Current flow temp.	28 °C		CH pressure	1.2 bar		Brine pressure	1.4 bar		Heating only comp.			Warning message			Warning message			<p>Day, date, time as well as flow temperature, heating system pressure and heat source pressure are displayed. Current flow temp: Current flow temperature in the unit. Heating system pressure: Pressure sensor heating circuit. Pressure heat source: Pressure of the heat source (pressure sensor, heat source circuit, brine pressure). Heating only comp.: this status message provides information on the current operating status. The following are possible: Heating only comp. Heating comp & ZH CH: ZH only CH:Comp&aux off WW:Comp&aux off WW: Comp only WW: ZH only Peak Rate: WW Peak Rate: Stand-by Acceleration mode Frost prot. Heating Frost prot. Cylind. Legionella protect. Automatic pump spin Floor drying Venting mode Fault shutdown: heating Error shutdown: heating Fault shutdown: DHW Error shutdown: DHW Malfunction Blocking error Operation interlock CH Comp overrun WW Comp overrun CH return too high</p> <p>Under critical operating conditions a warning message is displayed in both lower display lines. These lines are empty when the operating conditions are normal.</p>
Mon. 21.04.08	16:49	☰ 1																				
Current flow temp.	28 °C																					
CH pressure	1.2 bar																					
Brine pressure	1.4 bar																					
Heating only comp.																						
Warning message																						
Warning message																						

Table 5.1 Settable parameters in the operator level (ctnd.)

5 Operation



Display shown	Description	Factory setting
<div style="border: 1px solid black; padding: 5px;"> <p>HK2 ☰ 2</p> <p>Parameters</p> <hr/> <p>Operating mode heating ☀</p> <p style="padding-left: 20px;">>Auto</p> <p>Set value day 22 °C</p> <p>Night set back temp. 15 °C</p> <p>>Select operating mode</p> </div>	<p>The room set target temperature is the temperature to which the heating should be regulated in the operating mode "Heat" or during the time slots.</p> <p></p> <p>Note: Select a room temperature that is just high enough to ensure your personal well-being (e.g. 20 °C). Each degree over and above the set value means an increase in energy consumption of around 6% per annum.</p> <p>The set-back temperature is the temperature to which the heating is regulated during the set-back period. An individual set-back temperature can be set for each heating circuit.</p> <p>The set operating mode determines under which conditions the assigned heating circuit or hot water circuit should be regulated.</p> <p></p> <p>The following operating modes are available for heating circuits:</p> <p>Auto: The operation of the heating circuits alternates between the Heating and Energy Saving operating modes in accordance with a settable timer programme.</p> <p>Eco: The operation of the heating circuits alternates between the Heating and Off operating modes in accordance with a settable timer programme. The heating circuit is switched off during the set-back period provided the frost protection function (which depends on the outside temperature) is not activated.</p> <p>Heating: The heating circuit operates at the room set target temperature regardless of any settable timer programme.</p> <p>Energy sav: The heating circuit operates at the set-back temperature regardless of any settable timer programme.</p> <p>Off: The heating circuit is off, provided that the frost protection function (depending on the external temperature) is not activated.</p> <p>Note: Additional heating circuits are displayed, depending on the system configuration.</p>	<p>Room set target temp.: 20 °C</p> <p>Set-back temp.: 15 °C</p>

Table 5.1 Settable parameters in the operator level (ctnd.)









Display shown	Description	Factory setting																					
<table border="1"> <tr> <td colspan="3">DHW loading  4</td> </tr> <tr> <td colspan="3">Parameters</td> </tr> <tr> <td>Operating mode WW</td> <td>Auto</td> <td>Auto</td> </tr> <tr> <td>Max. DHW temp.</td> <td>60 °C</td> <td>60 °C</td> </tr> <tr> <td>Min. DHW temp.</td> <td>44 °C</td> <td>44 °C</td> </tr> <tr> <td>Cylinder temp. REAL</td> <td>51 °C</td> <td>51 °C</td> </tr> <tr> <td colspan="3">>Select set target temperature</td> </tr> </table>	DHW loading  4			Parameters			Operating mode WW	Auto	Auto	Max. DHW temp.	60 °C	60 °C	Min. DHW temp.	44 °C	44 °C	Cylinder temp. REAL	51 °C	51 °C	>Select set target temperature			<p>For connected domestic hot water cylinders and the circulation circuit the operating modes Auto, On and Off are possible.</p> <p>The maximum WW temperature determines the temperature to which the domestic hot water cylinder should be heated.</p> <p>The minimum WW temperature determines the limit below which the domestic hot water cylinder is heated.</p> <p>Note: The maximum WW temperature is only displayed when the auxiliary hot water heating is enabled.</p> <p>Without electric auxiliary heating, the WW temperature is limited by the pressure sensor control shut-off in the cooling circuit and cannot be adjusted!</p> <p>Cylinder temp. REAL: Current temperature in the domestic hot water cylinder.</p>  <p>We recommend that hot water generation be achieved without the electric auxiliary heating by this method, the maximum WW temperature is determined by the high pressure cut-out in the heat pump cooling circuit. This cut-out corresponds to a maximum hot water temperature of 58 °C. In order to keep the heat pump starts to an absolute minimum as low a min. hot water temperature as possible should be selected.</p>	<p>Min. hot water temp. 44 °C</p>
DHW loading  4																							
Parameters																							
Operating mode WW	Auto	Auto																					
Max. DHW temp.	60 °C	60 °C																					
Min. DHW temp.	44 °C	44 °C																					
Cylinder temp. REAL	51 °C	51 °C																					
>Select set target temperature																							
<table border="1"> <tr> <td colspan="3">HK2  5</td> </tr> <tr> <td colspan="3">Time programme</td> </tr> <tr> <td colspan="3">>Mon</td> </tr> <tr> <td>1</td> <td>00:00</td> <td>24:00</td> </tr> <tr> <td>2</td> <td>:</td> <td>:</td> </tr> <tr> <td>3</td> <td>:</td> <td>:</td> </tr> <tr> <td colspan="3">>Select weekday/block</td> </tr> </table>	HK2  5			Time programme			>Mon			1	00:00	24:00	2	:	:	3	:	:	>Select weekday/block			<p>You can set the heating times for each heating circuit in the "HK2-Timer programme" menu.</p> <p>Up to three heating times can be programmed per day or block. The control system operates according to the heating curve and the room setpoint temperature.</p>  <p>The set back times can be dispensed with, depending on the tariff agreement with power company (VNB) or the construction of the house.</p> <p>Power companies offer their own discounted tariffs for heat pumps. It can make sense on economic grounds to make use of the more favourable off-peak power.</p> <p>In low-energy houses (in Germany standard as from 1st February 2002 energy conservation regulation) the room temperature reduction can be dispensed with owing to low heat losses.</p> <p>The desired set-back temperature must be set in menu 2.</p>	<p>Mon - Sun</p> <p>0:00 - 24:00</p>
HK2  5																							
Time programme																							
>Mon																							
1	00:00	24:00																					
2	:	:																					
3	:	:																					
>Select weekday/block																							

Table 5.1 Settable parameters in the operator level (ctnd.)

5 Operation



Display shown	Description	Factory setting																		
<div style="border: 1px solid black; padding: 5px;"> <p>DHW loading ☰ 5</p> <p>Time programme</p> <hr/> <p>>Mon</p> <table style="width: 100%; border-collapse: collapse;"> <tr> <td style="width: 10%; text-align: center;">1</td> <td style="width: 15%; text-align: center;">06:00</td> <td style="width: 15%; text-align: center;">22:00</td> <td style="width: 15%;"></td> <td style="width: 15%;"></td> <td style="width: 15%;"></td> </tr> <tr> <td style="text-align: center;">2</td> <td style="text-align: center;">:</td> <td style="text-align: center;">:</td> <td></td> <td></td> <td></td> </tr> <tr> <td style="text-align: center;">3</td> <td style="text-align: center;">:</td> <td style="text-align: center;">:</td> <td></td> <td></td> <td></td> </tr> </table> <hr/> <p>>Select weekday/block</p> </div>	1	06:00	22:00				2	:	:				3	:	:				<p>You can set the times at which the domestic hot water cylinder is heated in the "WW Timer Programme" menu.</p> <p>Up to three times can be programmed per day or block.</p>  <p>The hot water generation should only be active at times when really hot water is to be run. Please set this timer programme to your minimum requirements.</p> <p>As an example, for working people a window from 6.00 - 8.00hrs. and a second window from 17.00 - 23.00hrs.can minimise the energy consumption due to hot water generation.</p>	<p>Mon - Fri 6:00 - 22:00 hrs.</p> <p>Sat 7:30 - 23:30</p> <p>Su. 7:30 - 22:00</p>
1	06:00	22:00																		
2	:	:																		
3	:	:																		
<div style="border: 1px solid black; padding: 5px;"> <p>Circulation pump ☰ 5</p> <p>Time programme</p> <hr/> <p>>Mon</p> <table style="width: 100%; border-collapse: collapse;"> <tr> <td style="width: 10%; text-align: center;">1</td> <td style="width: 15%; text-align: center;">06:00</td> <td style="width: 15%; text-align: center;">22:00</td> <td style="width: 15%;"></td> <td style="width: 15%;"></td> <td style="width: 15%;"></td> </tr> <tr> <td style="text-align: center;">2</td> <td style="text-align: center;">:</td> <td style="text-align: center;">:</td> <td></td> <td></td> <td></td> </tr> <tr> <td style="text-align: center;">3</td> <td style="text-align: center;">:</td> <td style="text-align: center;">:</td> <td></td> <td></td> <td></td> </tr> </table> <hr/> <p>>Select weekday/block</p> </div>	1	06:00	22:00				2	:	:				3	:	:				<p>You can set the times at which the circulation pump is to be operational in the "Circulation Pump Timer Programme" menu.</p> <p>Up to three times can be programmed per day or block.</p> <p>If the hot water operating mode (see menu ☰3) is set to "ON", the circulation pump runs continuously.</p>  <p>The timer programme circulation pump should correspond to the timer programme hot water, if necessary the time slots could be selected even more restrictively.</p> <p>If the desired hot water temperature is obtained quickly enough without switching on the circulation pump, the circulation pump can likewise be deactivated.</p> <p>In addition, you can briefly activate the circulation pump by means of electronic pushbutton switches mounted in the immediate vicinity of the taps and connected to the heat pump (the same idea as stairwell lighting). The operating times of the circulation pump can thus be optimally matched to the actual need.</p> <p>Consult your expert technician about doing this.</p>	<p>Mon - Fri 6:00 - 22:00 hrs.</p> <p>Sat 7:30 - 23:30</p> <p>Su. 7:30 - 22:00</p>
1	06:00	22:00																		
2	:	:																		
3	:	:																		

Table 5.1 Settable parameters in the operator level (ctnd.)







Display shown	Description	Factory setting
<p>Holiday programming for cpl. System  6</p> <hr/> <p>Period of time</p> <p>1 >06.01.08 08.01.08</p> <p>2 14.01.08 30.01.08</p> <p>Room Temp. setpoint 12°C</p> <p>>Set start day</p>	<p>For the controller and its connected system components it is possible to programme two holiday periods with the introduction of the date. Moreover, the desired target room temperature can be set for holidays, i.e. regardless of the preset timer programme. After the holiday time has elapsed, the controller automatically goes back to the previously selected operating mode. The holiday program can be activated only in auto and eco operating mode. Connected cylinder charging circuits or circulation pump circuits are automatically switched to OFF operating mode during the holiday timer programme.</p>  <p>Connected cylinder charging circuits or circulation pump circuits are automatically switched to OFF operating mode during the holiday timer programme. Prolonged periods of absence can be set in the display "Programme holidays". The target temperature during this period should be selected to be as low as possible. During this period hot water generation is not in operation.</p>	<p>Period 1: 01.01.2003 - 01.01.2003</p> <p>Period 2: 01.01.2003 - 01.01.2003</p> <p>Room Temp. setpoint 15°C</p>
<p>Basic data  7</p> <hr/> <p>Date 21.04.08</p> <p>Day of week Mo</p> <p>Time 09:35</p> <hr/> <p>>Settable values</p>	<p>You can set the current date, the day of the week and the current time, if DCF radio clock reception is not possible, in the "Basic Data" menu. These settings apply to all connected system components.</p>	
<p>Code layer  8</p> <hr/> <p>Code number: >0 0 0 0</p> <hr/> <p>>Set figures</p>	<p>To access the Code level (Installer level), the appropriate code must be entered. To view setting parameters without entering the code, you must press the dial  once. You can then view all parameters of the code level by turning the dial  but not change them. As operator, without entering the code, you can view all menus in the code level however not modify them.</p> <p>Caution! Do not try to access the code level by making arbitrary entries in the code level. Unintentional modification of the system-specific parameters can cause malfunctions or damage to the heat pump.</p>	

Table 5.1 Settable parameters in the operator level (ctnd.)



5 Operation

5.6 Installer Menu

Special functions can be selected only from the basic display. To do so press the left-hand dial .

You must turn the dial  to alter the parameter.

The following special functions can be selected:



- Energy saving function: Press dial  1 x
- Party function: Press dial  2 x
- One-time charging: Press dial  3 x

To activate one of the functions, you merely have to select it. In the energy saving function it is additionally necessary to enter the time until which the energy saving function (regulation to set-back temperature) is to apply.

The basic display appears either after the function has elapsed (reaching the time) or by pressing the dial  again.

Display shown	Description
<div style="border: 1px solid black; padding: 5px;"> <p>We 16.02.08 9:35</p> <hr/> <p>Energy saving enabled</p> <hr/> <p>>Select end time</p> </div>	<p>Saving function: With the saving function you can set back the heating times for a set-table period.</p> <p>Enter the time for the end of the saving function in the format hh:mm (hour:minute).</p>
<div style="border: 1px solid black; padding: 5px;"> <p>We 16.02.08 9:35</p> <hr/> <p>Party function enabled</p> <hr/> </div>	<p>Party function: With the party function you can continue the heating and hot water times beyond the next switch-off time up to the next heating start. The party function can only be used for the heating circuits or hot water circuits for which the operating mode "Auto" or "ECO" is set.</p>
<div style="border: 1px solid black; padding: 5px;"> <p>We 16.02.08 9:35</p> <hr/> <p>one-time DHW tank loading enabled</p> <hr/> </div>	<p>One-time charging: This function allows you to charge the hot water cylinder once, regardless of the current time program.</p>

Table 5.2 Special functions

- Reset to default setting: Keep dial  and dial  pressed for longer than 5 seconds. After that you can select whether to reset only the timer programme or all values to the default settings.

Display shown	Description																		
<table border="1"> <tr> <td>We</td> <td>21.04.08</td> <td>9:35</td> </tr> <tr> <td colspan="3">Factory setting</td> </tr> <tr> <td>Cancel</td> <td></td> <td>NO/YES</td> </tr> <tr> <td>Time programme</td> <td></td> <td>NO/YES</td> </tr> <tr> <td>Everything</td> <td></td> <td>NO/YES</td> </tr> <tr> <td colspan="3">>Settable values</td> </tr> </table>	We	21.04.08	9:35	Factory setting			Cancel		NO/YES	Time programme		NO/YES	Everything		NO/YES	>Settable values			<p>The default settings are re-established.</p> <p>Caution! Ensure that a qualified technician performs the default setting reset. The system-specific settings are reset. The system can be shut down. The system does not suffer damage.</p> <p>Press both dials for at least 5 seconds to request the menu default setting.</p>
We	21.04.08	9:35																	
Factory setting																			
Cancel		NO/YES																	
Time programme		NO/YES																	
Everything		NO/YES																	
>Settable values																			

Table 5.3 Re-establishing the default setting

5.7 Starting up the heat pump

The start-up of your heat pump was carried out after installation by your expert technician company. A repeated start-up will not even be necessary in the event that your heat pump disconnects from the mains unexpectedly, for example as a result of a voltage drop (power cut, circuit breaker defective, circuit breaker deactivated). Your geoTHERM heat pump has an automatic reset function, i.e. the heat pump reverts automatically to its starting condition, provided no fault is present in the heat pump itself. Find out what to do in the event of a fault in Chap. 5.10.

5.8 Shutting down the heat pump

A shutdown of the heat pump is only possible via the operating panel by deactivating heating and hot water generation in the respective menus (see Sect. 5.4, User Level Displays).



Note!
Should it be necessary to remove all electric power from the heat pump installation, then switch off the circuit breaker on your heating system.

5.9 Inspection

An annual inspection/maintenance of the unit by a specialist is a prerequisite for continuing operational safety, reliability and a long working life.



Danger!
Inspections/Maintenance work not carried out can result in damage to property and personal injury.
Have the inspection, maintenance and repairs carried out only by a recognised expert technician company.

Only genuine Vaillant spare parts may be used for inspections, maintenance and repair work to ensure the perfect long-term working order of all functions of your Vaillant appliance and to prevent the approved series condition from being changed. Any spare parts which might be required are listed in the relevant current spare parts catalogues. Information can be obtained from Vaillant Customer Service Centres.

5.10 Troubleshooting and diagnosis

5.10.1 Error messages on the controller

Error messages appear ca. 20 seconds after the error has occurred on the display and are written in the error memory of the controller when the error has been present for ca. 3min. where the engineer can view it at a later date.

Error History	11
Fault number	>1
Fault code	41
16.02.08 07:18	
Error CH circuit	
Sensor T3 heat source	

Fig. 5.3 Error message in the error memory Menu 11

The geoTHERM control system has various malfunction types:

- Malfunction of **components** which are connected via **eBUS**.
- **Temporary shutdown**
The heat pump remains in operation. The error is displayed and disappears independently when the cause of the fault is removed.
- **Fault-induced shutdown**
The heat pump is shut down. It can only be restarted after the cause of the fault has been removed by the expert technician and the error reset.
- Moreover, **other errors/malfunctions** can occur on the unit or system.



Caution!
Heat pump malfunction.
Immediately notify your expert technician if error messages appear on the display on the operating panel which are not listed in tables 5.4 to 5.7.
Do not attempt to remove the source of the malfunction yourself.



Note!
Not all of the following listed malfunctions have to be dealt with by an expert technician.
If you are unsure whether you can remedy the fault yourself or not or if the error occurs repeatedly contact your expert technician or Vaillant customer service.

5.10.2 Activating emergency mode

Depending on the type of malfunction the expert technician can set the heat pump to continue operation in emergency mode (via an integrated electric auxiliary heating) until the cause of the error is remedied, and either for heating operation (display "heating priority"), for hot water operation (display "hot water priority") or for both (display "heating priority/hot water priority"), see the following tables, column "emergency operation".

5.10.3 Errors/malfunctions that you can remedy

Malfunction sign	Possible cause	Remedy
Noise in the heating circuit.	Dirt in the heating circuit.	Bleeding heating circuit.
	Faulty pump.	
	Air in the heating circuit.	

Table 5.4 Other malfunctions

5.10.4 Warning messages

The following warning messages do not cause a malfunction in the operation of the heat pump. The heat pump is not shut down. Take note of the error code and text and discuss this during the next inspection with the expert technician.

Fault code	Error text/description
26	Overheating on compressor pressure side
36	Low brine pressure

Table 5.5 Warning messages, no shutdown

5.10.5 Temporary malfunctions

The heat pump is shut down temporarily and starts up again independently when the cause of the fault is removed.

Depending on the error the heat pump switches back on automatically after 5 or 60 minutes.

Take note of the error code and text and discuss this during the next inspection with the expert technician.

Fault code	Error text/description
20	Frost protection heat source monitoring source outlet Temperature difference of the heat source > set value "permitted temp. difference" This error message is deactivated as standard and can only be activated via vrDIALOG parameter "permitted temp. difference" (20K difference means deactivated).
22	Frost protection heat source over. source outlet Source outlet temperature too low (<parameter freezing protection in menu A4)
27	Coolant pressure too high The integrated high pressure switch tripped at 30 bar (g). The heat pump cannot be restarted until after 60 min. at the earliest.
28	Coolant pressure too low The integrated low pressure switch tripped at 1.25 bar (g).
29	Coolant pressure outside the range If the error occurs twice in a row the heat pump cannot be started until after 60 min. at the earliest.

Table 5.6 Temporary malfunctions

5 Operation

5.10.6 Blocking error

Errors could occur which result in the shutdown of the heat pump.

Fault code	Error text/description	Emergency mode
32	Error heat source sensor T8 Short-circuit in the sensor	possible
33	Error heat circuit pressure sensor short-circuit in the pressure sensor	
34	Error brine pressure sensor short-circuit in the pressure sensor	possible
40	Error comp outlet sensor T1 Short-circuit in the sensor	possible
41	Error heat source sensor T3 Short-circuit in the sensor	possible
42	Error HP return sensor T5 Short-circuit in the sensor	possible
43	Error HP flow sensor T6 Short-circuit in the sensor	possible
44	Error external sensor AF Short-circuit in the sensor	possible
45	Error DHW tank sensor SP Short-circuit in the sensor	possible
46	Error HB flow sensor VF1 Short-circuit in the sensor	possible
47	Error HB return sensor RF1 Short-circuit in the sensor	possible
48	Error flow sensor VF2 Short-circuit in the sensor	WW operation possible
52	Sensors are not suited to the hydraulic plan	–
60	Frost protection heat source monitoring source outlet Error 20 has occurred three times in a row	possible
62	Frost protection heat source monitoring source outlet Error 22 has occurred three times in a row	possible

Table 5.7 Error shutdown

Fault code	Error text/description	Emergency mode
72	Flow temperature too high for underfloor heating Flow temperature is for 15 min. higher than a set value (max. HK temp. + compr. hysteresis + 2K).	–
81	Coolant pressure too high Error 27 has occurred three times in a row	possible
83	Coolant pressure too low check heat source Error 28 has occurred three times in a row	possible
84	Coolant pressure outside the range Error 29 has occurred three times in a row	possible
90	Heating system pressure too low Pressure <0.5 bar Heat pump switches off and starts up automatically when the pressure increases to over 0.7 bar	–
91	Brine pressure too low Pressure <0.2 bar Heat pump switches off and starts up automatically when the pressure increases to over 0.4 bar	possible
96	Error pressure sensor refrigerant circuit short-circuit in the pressure sensor	possible
97	No power for compressor	possible

Table 5.7 Fault-induced shutdown (ctnd.)

- Consult your expert technician about doing this.



Note!

Only an expert technician can remedy the fault and reset the error code.

Once the expert technician has remedied the error and reset the error he can restart the heat pump.

6 Warranty and customer service

Vaillant provide a full parts and labour warranty for this appliance.

The appliance must be installed by a suitably competent person in accordance with the Gas Safety (Installation and Use) Regulations 1998, and the manufacturer's instructions.

In the UK 'CORGI' registered installers undertake the work in compliance with safe and satisfactory standards.

All unvented domestic hot water cylinders must be installed by a competent person to the prevailing building regulations at the time of installation (G3).

Terms and conditions apply to the warranty, details of which can be found on the warranty registration card included with this appliance. Failure to install and commission this appliance in compliance with the manufacturer's instructions may invalidate the warranty (this does not affect the customer's statutory rights).

Vaillant Service

To ensure regular servicing, it is strongly recommended that arrangements are made for a Maintenance Agreement. Please contact Vaillant Service Solutions (0870 6060 777) for further details.

7 Appendix

7 Appendix

7.1 Technical data

Description	Unit	VWS 61/2 230 V	VWS 81/2 230 V	VWS 101/2 230 V
Article number	-	0010005501	0010005502	0010005503
Height without connections	mm	1200		
Width	mm	600		
Depth without pillars	mm	650		
Depth with pillars	mm	840		
Weight				
- with packaging	kg	156	163	167
- without packaging	kg	141	148	152
- ready for operation	kg	147	155	160
Rated voltage	-	1/N/PE 230 V 50 Hz		
- Heating circuit/Compressor		1/N/PE 230 V 50 Hz		
- Control circuit		1/N/PE 230 V 50 Hz		
- Auxiliary heating		1/N/PE 230 V 50 Hz		
Fuse, slow-blow				
Connected mains supply				
Alternative operation (Supply status 4 kW)	A	16/20	25/25	
Parallel operation	A	25/35	35/50	
Dual circuit supply WP charge rate				
- Individual compressor	A	16	25	25
- booster heating 2/4kW individual	A	16/20	16/20	16/20
Dual circuit supply special charge rate				
- Alternative operation (Supply status 4 kW)	A	16/20	25/25	25/25
Parallel operation	A	25/35	35/50	35/50
- pumps and controllers	A	4	4	4
Start-up current				
- without start-up current limiter	A	58	76	97
- with start-up current limiter	A	< 45	< 45	< 45
Rated power				
- min. for B-5W35	kW	1.4	1.8	2.4
- max. for B20W60	kW	2.8	4.0	4.9
- Auxiliary heating	kW	2/4	2/4	2/4
EN 60529 level of protection	-	IP 20		
Hydraulic connections				
- Heating circuit flow and return	mm	G 1 1/4", diameter 28		
- Heat source flow and return	mm	G 1 1/4", diameter 28		
Heat source circuit (brine circuit)				
- Brine type	-	Ethylene glycol 30%		
- max. operating pressure	MPa (bar)	0.3 (3)		
- min. inlet temperature	°C	-10		
- max. inlet temperature	°C	20		
- Nominal flow rate dT 3K	l/h	1453	1936	2530
- Residual head dT 3K	mbar	381	332	263
- Nominal flow rate dT 4K	l/h	1090	1452	1898
- Residual head dT 4K	mbar	461	429	380
- Electrical power consumption - pump	W	132	132	132
CH circuit				
- max. operating pressure	MPa (bar)	0.3 (3)		
- min. flow temperature	°C	25		
- max. flow temperature	°C	62		
- Nominal flow rate dT 5K	l/h	1061	1375	1803
- Residual head dT 5K	mbar	382	339	254
- Nominal flow rate dT 10K	l/h	517	697	848
- Residual head dT 10K	mbar	486	468	450
- Electrical power consumption - pump	W	93	93	93
refrigerant circuit				
- Coolant type	-	R 407 C		
- Quantity	kg	1.9	2.2	2.05
- Number of revolutions EX valve	-	9.0	9.0	9.0
- Permissible operating overpressure	MPa (bar)	2.9 (29)		
- Compressor type	-	Scroll		
- Oil	-	Ester		
- Oil filling quantity	l	1.3	1.45	1.45

Table 7.1 Technical data

Description	Unit	VWS 61/2 230 V	VWS 81/2 230 V	VWS 101/2 230 V
Heat pump performance data				
B0W35 dT5				
- Heating output	kW	6.0	8,1	10.5
- Power consumption	kW	1.4	1.9	2.5
- Performance figure/COP	-	4.2	4.2	4.2
B5W55				
- Heating output	kW	6.3	8.6	10.8
- Power consumption	kW	2.1	2.8	3.5
- Performance figure/COP	-	3.0	3.0	3.1
Internal sound level	dbA	49	51	53
Conforms to safety regulations	-	CE mark Low Voltage Directive 73/23/EWG EMC Directive 89/336/EWG EN 60335 ISO 5149		

Table 7.1 Technical data (cont.)

**Caution!**

R 407 C is a chlorine-free coolant which does not affect the ozone layer. Nevertheless, any servicing work on the cooling circuit should only be carried out by authorised specialists.

7.2 Data badge

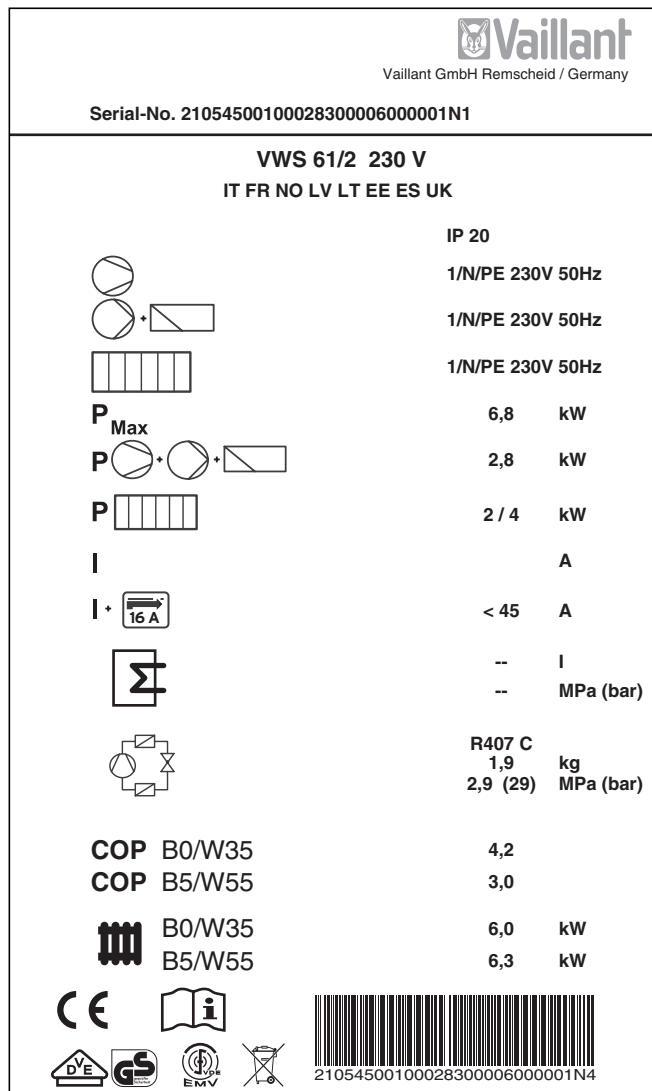

Fig. 7.1 Example of an identification plate

Explanation of the symbols on the identification plate

	Rated voltage - compressor	
	Rated voltage - pumps + controller	
	Rated voltage - auxiliary heating	
P_{Max}	Rated maximum power	
	Rated power - compressor, pumps and controller	
P	Rated power - auxiliary heating	
I	Start-up current without start-up current limiter	
I+	Start-up current with start-up current limiter	
	Service water tank capacity	
	Permissible rated overpressure	
	Coolant type	
	Filling quantity	
	Permissible rated overpressure	
COP B0/W35	Performance figure at a brine temperature of 0 °C and a heating flow temperature of 35 °C	
COP B5/W55	Performance figure at a brine temperature of 5 °C and a heating flow temperature of 55 °C	
	B0/W35	Thermal output with a brine temperature of 0 °C and a heating flow temperature of 35 °C
	B5/W55	Thermal output with a brine temperature of 5 °C and a heating flow temperature of 55 °C
CE	CE mark	
	VDE/GS mark	
	Read the Operating and Installation Manual!	
IP 20	Humidity protection class	
	Ensure proper disposal at the end of its useful life (not household waste)	
	Serial Number 21054500100028300006000001N4	

Table 7.2 Explanation of symbols

Vaillant Ltd

Nottingham Road ■ Belper ■ Derbyshire ■ DE56 1JT

Telephone 0845 602 2922 ■ www.vaillant.co.uk ■ info@vaillant.co.uk

0020045200_00 GB 082008