

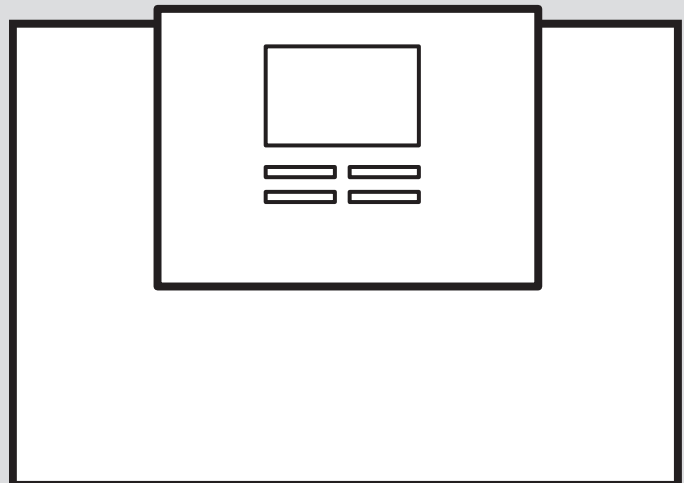

# Heat pump appliance interface

VWZ AI



en	Operating instructions .....	3
en	Installation instructions .....	14

# Operating instructions

## Contents

<b>1</b>	<b>Safety</b> .....	<b>4</b>
1.1	Action-related warnings .....	4
1.2	Intended use .....	4
1.3	General safety information .....	4
<b>2</b>	<b>Notes on the documentation</b> .....	<b>6</b>
<b>3</b>	<b>Product description</b> .....	<b>6</b>
3.1	Heat pump system .....	6
3.2	Control elements .....	6
3.3	Control panel .....	6
3.4	Description of the symbols .....	6
3.5	Functional description of buttons .....	7
3.6	Type designation and serial number .....	7
3.7	CE marking .....	7
3.8	Safety devices .....	7
<b>4</b>	<b>Operation</b> .....	<b>7</b>
4.1	Basic display .....	7
4.2	Operating concept .....	8
4.3	Menu display .....	8
4.4	Starting up the product .....	8
4.5	Setting the heating flow temperature .....	9
4.6	Setting the domestic hot water temperature .....	9
4.7	Switching off the product's functions .....	9
<b>5</b>	<b>Care and maintenance</b> .....	<b>10</b>
5.1	Caring for the product .....	10
5.2	Maintenance .....	10
5.3	Reading maintenance messages .....	10
5.4	Checking the filling pressure of the heating installation .....	10
<b>6</b>	<b>Troubleshooting</b> .....	<b>10</b>
6.1	Reading fault messages .....	10
6.2	Detecting and eliminating faults .....	10
<b>7</b>	<b>Decommissioning</b> .....	<b>11</b>
7.1	Temporarily decommissioning the product .....	11
7.2	Permanently decommissioning the product .....	11
<b>8</b>	<b>Recycling and disposal</b> .....	<b>11</b>
<b>9</b>	<b>Guarantee and customer service</b> .....	<b>11</b>
9.1	Customer service .....	11
	<b>Appendix</b> .....	<b>12</b>
<b>A</b>	<b>Troubleshooting</b> .....	<b>12</b>
<b>B</b>	<b>Overview of the end user operating level</b> .....	<b>12</b>

# 1 Safety

## 1.1 Action-related warnings

### Classification of action-related warnings

The action-related warnings are classified in accordance with the severity of the possible danger using the following warning signs and signal words:

#### Warning symbols and signal words



#### **Danger!**

Imminent danger to life or risk of severe personal injury



#### **Danger!**

Risk of death from electric shock



#### **Warning.**

Risk of minor personal injury



#### **Caution.**

Risk of material or environmental damage

## 1.2 Intended use

There is a risk of injury or death to the user or others, or of damage to the product and other property in the event of improper use or use for which it is not intended.

This product is a system component for controlling the heating circuits and domestic hot water generation in conjunction with a heat pump using a system control.

Intended use includes the following:

- observance of the operating instructions included for the product and any other installation components
- compliance with all inspection and maintenance conditions listed in the instructions.

The product is intended exclusively for domestic use.

The intended use only allows for these product combinations:

Outdoor unit	Heat pump control module
VWL ..5/6 A ..	VWZ AI

This product can be used by children aged from 8 years and above and persons with reduced physical, sensory or mental capabilities or lack of experience and knowledge if they have been given supervision or instruction concerning use of the product in a safe

way and understand the hazards involved. Children must not play with the product. Cleaning and user maintenance work must not be carried out by children unless they are supervised.

Any other use that is not specified in these instructions, or use beyond that specified in this document, shall be considered improper use. Any direct commercial or industrial use is also deemed to be improper.

#### **Caution.**

Improper use of any kind is prohibited.

## 1.3 General safety information

### 1.3.1 Danger caused by improper operation

Improper operation may present a danger to you and others, and cause material damage.

- ▶ Carefully read the enclosed instructions and all other applicable documents, particularly the "Safety" section and the warnings.
- ▶ Only carry out the activities for which instructions are provided in these operating instructions.

### 1.3.2 Risk of injury and material damage due to maintenance and repairs carried out incorrectly or not carried out at all

- ▶ Never attempt to carry out maintenance work or repairs on your product yourself.
- ▶ Faults and damage should be immediately eliminated by a competent person.
- ▶ Adhere to the maintenance intervals specified.

### 1.3.3 Risk of material damage caused by frost

- ▶ Ensure that the heating installation always remains in operation during freezing conditions and that all rooms are sufficiently heated.
- ▶ If you cannot ensure the operation, have a competent person drain the heating installation.

### 1.3.4 Material damage due to unsuitable installation room

If you are installing the product in a moist environment, the electronics may be damaged by moisture.

- ▶ Only install the product in dry rooms.

### 1.3.5 Benchmark



Vaillant is a licensed member of the Benchmark Scheme which aims to improve the standards of installation and commissioning of domestic heating and hot water systems in the UK and to encourage regular servicing to optimise safety, efficiency and performance.

Benchmark is managed and promoted by the Heating and Hotwater Industry Council. For more information visit [www.benchmark.org.uk](http://www.benchmark.org.uk).

- ▶ Please ensure that the installer has fully completed the Benchmark Checklist on the inside back pages of the installation instructions supplied with the product and that you have signed it to say that you have received a full and clear explanation of its operation. The installer is legally required to complete a commissioning checklist as a means of complying with the appropriate Building Regulations (England and Wales).

All installations must be notified to Local Area Building Control either directly or through a Competent Persons Scheme. A Building Regulations Compliance Certificate will then be issued to the customer who should, on receipt, write the Notification Number on the Benchmark Checklist.

This product should be serviced regularly to optimise its safety, efficiency and performance. The service engineer should complete the relevant Service Record on the Benchmark Checklist after each service.

The Benchmark Checklist will be required in the event of any warranty.

## 2 Notes on the documentation

- ▶ Always observe all operating instructions that are enclosed with the installation components.
- ▶ Store these instructions and all other applicable documents for further use.

These instructions apply only to:

Product
VWZ AI

## 3 Product description

### 3.1 Heat pump system

Design of a sample heat pump system with monoblock technology:

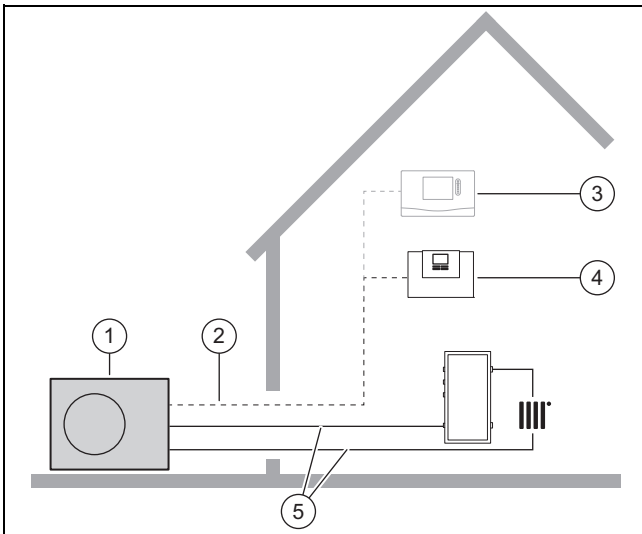

- |                             |                            |
|-----------------------------|----------------------------|
| 1 Heat pump, outdoor unit   | 4 Heat pump control module |
| 2 eBUS line                 | 5 Heating circuit          |
| 3 System control (optional) |                            |



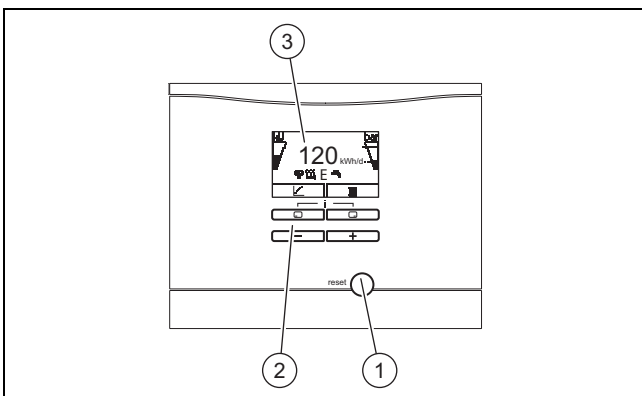

### 3.2 Control elements

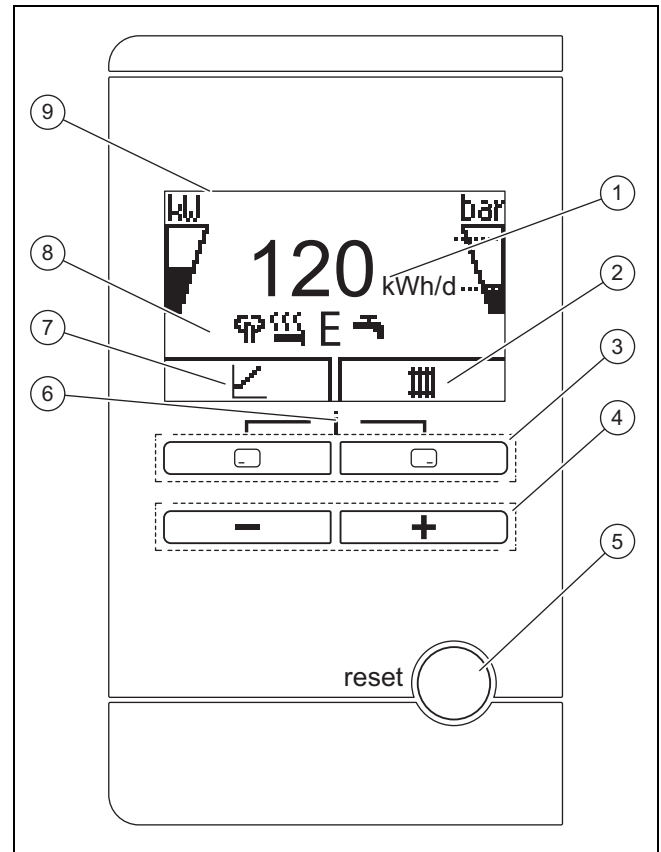

- |                    |           |
|--------------------|-----------|
| 1 Reset button     | 3 Display |
| 2 Control elements |           |



### 3.3 Control panel



- |  |   |
|--|---|
| 1 Displays the daily environmental energy yield  | 6 Access to the menu for additional information                       |
| 2 Display of the current assignment of the right-hand selection button   | 7 Display of the current assignment of the left-hand selection button |
| 3 Left- and right-hand selection buttons   | 8 Displays the symbols for the heat pump's current operating mode     |
| 4  and  button                             | 9 Display   |
| 5 Reset button, restart the product  |   |

### 3.4 Description of the symbols

If you do not press any buttons within one minute, the light goes out.

Symbol	Meaning	Explanation
	Compressor power	<ul style="list-style-type: none"> <li>– Not filled: Compressor not in operation</li> <li>– Partially filled: Compressor in operation. Partial load mode.</li> <li>– Fully filled: Compressor in operation. Full load mode.</li> </ul>
	Filling pressure in the building circuit (measured in the outdoor unit)	<p>The dashed lines show the permitted range.</p> <ul style="list-style-type: none"> <li>– Displayed statically: Filling pressure in the permitted range</li> <li>– Displayed flashing: Filling pressure outside of the permitted range</li> </ul>
	Noise reduction mode	<ul style="list-style-type: none"> <li>– Operation with reduced sound emissions</li> </ul>

Symbol	Meaning	Explanation
	Electric back-up heater	<ul style="list-style-type: none"> <li>– Displayed flashing: Electric back-up heater in operation</li> <li>– Displayed together with the "Heating mode" symbol: Electric back-up heater active for heating mode</li> <li>– Displayed together with the "Domestic hot water generation" symbol: Electric back-up heater active for domestic hot water mode</li> </ul>
	eco mode	– Energy-saving domestic hot water mode
	Heating mode	– Heating mode active
	Domestic hot water generation	– Domestic hot water mode active
	Cooling mode	– Cooling mode active
	Fault condition	– Appears instead of the basic display, may be an explanatory plain text display

### 3.5 Functional description of buttons

The two selection buttons are soft keys, meaning that they can be assigned different functions.

Button	Meaning
	<ul style="list-style-type: none"> <li>– Cancelling the change to a set value or activating an operating mode</li> <li>– Calling up a higher selection level in the menu</li> </ul>
	<ul style="list-style-type: none"> <li>– Confirming a set value or activating an operating mode</li> <li>– Calling up a lower selection level in the menu</li> </ul>
	Calling up the additional functions
or	<ul style="list-style-type: none"> <li>– Navigating between individual menu items</li> <li>– Increasing or decreasing the chosen set value</li> </ul>

Adjustable values flash in the display.

You must always confirm a change to a value. Only then is the new setting saved. You can press to cancel a process at any time. If you do not press any buttons for longer than 15 minutes, the display returns to the basic display.

### 3.6 Type designation and serial number

The type designation and serial number are on the data plate on the rear of the housing.

### 3.7 CE marking



The CE marking shows that the products comply with the basic requirements of the applicable directives as stated on the declaration of conformity.

The declaration of conformity can be viewed at the manufacturer's site.

### 3.8 Safety devices

#### 3.8.1 Frost protection function

The frost protection function for the system is controlled using the product itself or using the optional system control. If the system control fails, the product guarantees limited frost protection for the heating circuit.

At negative outdoor temperatures, there is an increased risk of the heating water freezing if a heat pump fault occurs, e.g. due to a power cut or a defective compressor.

#### 3.8.2 Low-water pressure protection

This function continuously monitors the pressure of the heating water in order to prevent a possible loss of heating water.

#### 3.8.3 Freeze protection

This function prevents the heating circuit from freezing when the heating flow temperature drops below a certain value.

If the heating flow temperature of the outdoor unit falls below 4° C, the compressor is switched on in order to increase the heating flow temperature.

#### 3.8.4 Pump blocking protection

This function prevents the pumps for heating water from sticking. The pumps, which were out of operation for 23 hours, are switched on for 10–20 seconds, one after the other.

## 4 Operation

### 4.1 Basic display

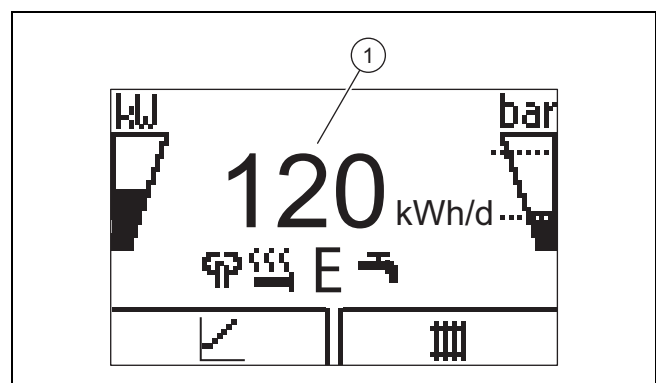

The displays shows the basic display with the current status of the product. The daily energy yield (1) is displayed in the centre of the display.

If you press a selection button, the activated function is displayed in the display.

As soon as a fault message is present, the basic displays switches to the fault message.

## 4.2 Operating concept

The product has two operating levels.

The operating level for the end user shows the most important information and offers setting options which do not require any special prior knowledge.

The operating level for the competent person is reserved for the competent person and is protected by a code.

Overview of the end user operating level (→ Page 12)

## 4.3 Menu display

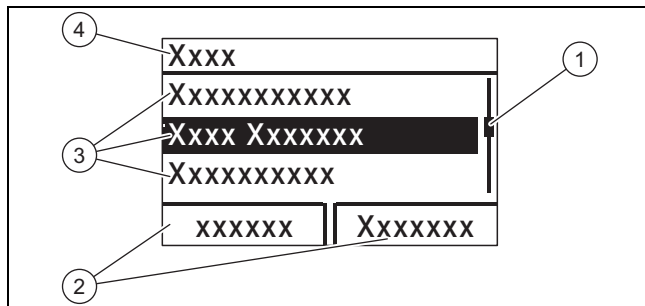

- |   |   |   |                              |
|---|---|---|------------------------------|
| 1 | Scroll bar                                  | 3 | Selection level list entries |
| 2 | Current assignment of the selection buttons | 4 | Selection level              |



### Note

Path details at the start of a section specify how to access this function, e.g. **Menu → Information → Contact details.**

## 4.4 Starting up the product

### 4.4.1 Opening the isolators

1. Ask the competent person who installed the product to explain to you where these isolators are located and how to handle them.
2. If installed, open the service valves in the heating installation's flow and return.
3. Open the cold-water isolation valve.

### 4.4.2 Switching on the product



### Note

The product does not have an on/off switch. The product is switched on and ready for operation as soon as it is connected to the power grid. It can only be switched off using the partition that is installed on-site, e.g. fuses or circuit breaker in the utility connection box.

1. Ensure that the product casing has been installed.
2. Switch on the product via the fuses in the utility connection box.
  - ◁ The "basic display" is shown in the product's operating display.
  - ◁ The "basic display" may also be shown in the display for the optional system control.

## 4.4.3 Adjusting the target cylinder temperature



### Danger!

#### Risk of death from legionella.

Legionella multiply at temperatures below 60 °C.

- ▶ Have a competent person inform you about the measures that should be taken to protect against Legionella in your installation.
- ▶ Do not set any water temperatures below 60 °C without consulting the competent person first.



### Danger!

#### Risk of death from legionella!

If you decrease the cylinder temperature, the risk of legionella spreading increases.

- ▶ Activate the anti-legionella times in the system control and set them.

Depending on the source of the energy obtained from the environment, target cylinder temperatures of up to 70 °C can be reached with the compressor. In order to achieve energy-efficient domestic hot water generation predominantly from the energy extracted from the environment, the factory setting for the desired domestic hot water temperature must be adjusted on the optional system control and/or on the heat pump's control panel.

**Condition:** System control connected

- ▶ To do this, adjust the target cylinder temperature (**Desired DHW circuit temperature**) to between 50 and 55 °C.
- ▶ Also switch on the electric back-up heater for the domestic hot water generation so that, also at outdoor temperatures below -10 °C and above +30 °C, the required 60 °C can be achieved for the anti-legionella function time programme.

**Condition:** No system control connected

- ▶ To do this, set the target cylinder temperature (**domestic hot water target cylinder temp.**) to 65 °C.



### Note

If no system control is connected, the time programme for the anti-legionella function is not available. To still ensure anti-legionella function, the target cylinder temperature must therefore be set higher.

- ▶ Also switch on the electric back-up heater for the domestic hot water generation so that, at outdoor temperatures below -10 °C and above +30 °C, the required 60 °C can also be achieved for the anti-legionella function.

## 4.4.4 Yield indicator

App, boiler and system control display estimated values for energy consumption, energy yields and efficiencies based on an extrapolation. The displayed values in the app may differ based on the different update intervals when compared to



the displays in the control panels for the boilers and system control.

Among other things, the values depend on:

- Installation and type of heating installation
- User behaviour
- Seasonal influences
- Tolerances and components

External consumers and generators in the household (e.g. ext. heating pumps or valves) are not taken into consideration.

Deviations between the displayed values and the actual values may be considerable; the specifications are therefore not suitable to be used to create or compare energy billing.

When replacing the PCB, the values for energy consumption, energy yields and efficiencies are reset in the boiler's control panel.

#### 4.4.5 Displaying the Live Monitor

**Menu** → **Live Monitor**

You can use the Live Monitor to view the current status of the product.

#### 4.4.6 Displaying the building circuit pressure

**Menu** → **Live Monitor** → **Building circuit pressure**

You can use this function to display the current filling pressure of the heating installation.

#### 4.4.7 Reading the operating statistics

**Menu** → **Information** → **Heating op. hours**







**Menu** → **Information** → **DHW operating hours**

**Menu** → **Information** → **Cooling op. hours**

**Menu** → **Information** → **Total operating hours**

You can use this function to display the operating hours for heating mode, for domestic hot water mode, for cooling mode and for overall operation.

#### 4.4.8 Setting the language

1. If you want to set another language, press **and hold**  and  **at the same time**.
2. Also press the reset button for a short time.
3. **Press and hold**  and  until the display shows the language setting.
4. Select the required language by pressing  or .
5. Press (OK) to confirm your selection.
6. Once you have set the correct language, press (OK) again to confirm this.

#### 4.4.9 Set display contrast

**Menu** → **Basic settings** → **Display contrast**

- ▶ You can set the contrast here.

#### 4.4.10 Serial number and article number

**Menu** → **Information** → **Serial number**

The product's serial number is displayed.

The article number is found in the second line of the serial number.



#### 4.4.11 Contact details for the competent person

**Menu** → **Information** → **Contact data** **Phone number**

If the competent person has entered their telephone number during the installation, you can read it here.

#### 4.5 Setting the heating flow temperature

**Condition:** No system control connected



- ▶ Press  in the basic display.
- ▶ Use  or  to change the value and confirm this.

**Condition:** System control connected

- ▶ Set the heating flow temperature on the system control, → System control operating instructions.

#### 4.6 Setting the domestic hot water temperature

**Condition:** No system control connected

- ▶ Press  in the basic display.
- ▶ Use  or  to change the value and confirm this.



**Condition:** System control connected

- ▶ Set the domestic hot water temperature on the system control, → System control operating instructions.

#### 4.7 Switching off the product's functions

##### 4.7.1 Switching off heating mode (Summer mode)

**Condition:** No system control connected



- ▶ Press  in the basic display.
- ▶ Use  to change the value to zero and confirm this.

**Condition:** System control connected

- ▶ Switch off heating mode on the system control (summer mode), → System control operating instructions.

##### 4.7.2 Switching off domestic hot water generation

**Condition:** No system control connected

- ▶ Press  in the basic display.
- ▶ Use  to set the value to zero and confirm this.

**Condition:** System control connected

- ▶ Switch off the domestic hot water generation at the system control (→ System control operating instructions).

##### 4.7.3 Frost protection function



#### Caution.

#### Risk of material damage due to frost.

The frost protection function cannot guarantee circulation through the entire heating installation. Under certain circumstances, there is therefore a risk of frost to certain parts of the heating installation, which may cause damage.

- ▶ During a period of frost, ensure that the heating installation remains in operation

and that all rooms are sufficiently heated, even when you are away.

- ▶ It is strongly recommended that antifreeze is used for filling those parts of the installation which are at risk of frost.

To ensure that the frost protection devices are permanently ready for operation, you must leave the system switched on.

Another way to protect the heating installation and the product from frost for very long switch-off periods is to drain them completely.

- ▶ Consult a competent person about this.

## 5 Care and maintenance

### 5.1 Caring for the product

- ▶ Clean the casing with a damp cloth and a little solvent-free soap.
- ▶ Do not use sprays, scouring agents, detergents, solvents or cleaning agents that contain chlorine.

### 5.2 Maintenance

An annual inspection of the product carried out by a competent person is a prerequisite for ensuring that the product is permanently ready and safe for operation, reliable, and has a long working life.

### 5.3 Reading maintenance messages

If the  symbol is shown in the display, the product requires maintenance work or the product is in restricted mode (comfort protection). The product is not in fault mode; it continues to operate.

- ▶ Consult a competent person.

**Condition: Lhm. 37** is displayed

The product is in Comfort protection mode. The product has detected a permanent fault and continues to run with restricted comfort.

### 5.4 Checking the filling pressure of the heating installation



#### Note

To avoid operating the installation with insufficient water volume and to prevent possible damage associated with this, the product is fitted with a pressure sensor and a digital pressure display.

To ensure that the heating installation operates properly, the filling pressure must be between 0.1 MPa and 0.15 MPa (1.0 bar and 1.5 bar) when the heating installation condition is cold.

If the heating installation extends over several storeys, a higher filling pressure may be required for the heating installation. Ask a competent person for details.



#### Note

If the pressure falls below 0.07 MPa (0.7 bar), message M32 appears.

If the pressure rises above 0.07 MPa (0.7 bar), message M32 goes out.

In addition, the  symbol is displayed after approx. one minute.

If the filling pressure of the heating installation falls below 0.05 MPa (0.5 bar) for longer than one minute, fault message F.22 and the current filling pressure appear alternately in the display.

If the blocking time has elapsed or if the filling pressure of the heating installation rises above 0.05 MPa (0.5 bar), fault message F.22 goes out.

1. Use **Menu** → **Live Monitor Water pressure** to display the filling pressure of the heating installation.
2. If the pressure drops frequently, identify and eliminate the reason for the pressure loss of heating water. Inform a competent person of this.

## 6 Troubleshooting

### 6.1 Reading fault messages

Fault messages have priority over all other displays and are shown on the display instead of the basic display. If several faults occur at the same time, these are displayed alternately for two seconds each.

Depending on the type of fault, the system can work in limp home mode in order to maintain the heating mode or domestic hot water generation.

#### F.723 Building circuit: Pressure too low

If the filling pressure falls below the minimum pressure, the heat pump will be switched off automatically.

- ▶ Inform your competent person so that he can top up the heating water.

### 6.2 Detecting and eliminating faults

- ▶ If problems occur whilst operating the product, you can carry out certain checks with the aid of the table. Troubleshooting (→ Page 12)
- ▶ If the product is not functioning correctly, even though you have checked the points listed in the table, contact a competent person.

## 7 Decommissioning

### 7.1 Temporarily decommissioning the product

- ▶ Use the partition that is installed on-site (e.g. fuses or power switches) to disconnect the product from the power supply.

### 7.2 Permanently decommissioning the product

- ▶ Have a competent person permanently decommission and dispose of the product.

## 8 Recycling and disposal

### Disposing of the packaging

- ▶ The competent person who installed your product is responsible for the disposal of the packaging.

### Disposing of the product



■ If the product is labelled with this mark:

- ▶ In this case, do not dispose of the product with the household waste.
- ▶ Instead, hand in the product to a collection centre for waste electrical or electronic equipment.

## 9 Guarantee and customer service

### 9.1 Customer service

The contact details for our customer service are provided on the back page or on our website.

# Appendix

## A Troubleshooting

Problem	Possible cause	Remedy
No domestic hot water, heating remains cold; product does not start up	Building power supply switched off	Switch on building power supply
	Domestic hot water or heating set to "off"/domestic hot water temperature or target temperature set too low	Ensure that domestic hot water mode and/or heating mode is activated in the system control. Set the domestic hot water temperature in the system control to the required value.
	Air in the heating installation	Purging the radiators If the problem occurs again: Inform the competent person
Domestic hot water mode without any problems; heating does not start	No heat requirement via the control	Check the timer programme on the control and correct if necessary Check the room temperature and, if required, correct the target room temperature (→ Control operating instructions)

## B Overview of the end user operating level

Setting level	Values		Unit	Increment, select	Factory setting	Setting
	Min.	Max.				
<b>Basic display</b> → Right-hand selection button						
Room temperature setpoint *	Current value		°C			
Manual cooling demand*						
<b>Basic display</b> → Left-hand selection button						
Domestic hot water cylinder target temperature*	Current value		°C			
Actual DHW cylinder temperature*	Current value		°C			
<b>Yield indicator</b> →						
Energy yield: Day, Heating	Cumulative value		kWh			
Energy yield: Day, Domestic hot water	Cumulative value		kWh			
Energy yield: Day, Cooling	Cumulative value		kWh			
Energy yield: Month, Heating	Cumulative value		kWh			
Working figure: Month, Heating	Cumulative value					
Energy yield: Total, Heating	Cumulative value		kWh			
Working figure: Total, Heating	Cumulative value					
Energy yield: Month, Cooling	Cumulative value		kWh			
SEER, month, cooling	Cumulative value					
Energy yield: Total, Cooling	Cumulative value		kWh			
SEER, total, cooling	Cumulative value					
Energy yield: Month, Domestic hot water	Cumulative value		kWh			
Working figure: Month, Domestic hot water	Cumulative value					
Energy yield: Total, Domestic hot water	Cumulative value		kWh			
Working figure: Total, Domestic hot water	Cumulative value					
Total energy consumption	Cumulative value		kWh			
<b>Live Monitor</b> →						
Current status message(s)	Current value					
Building circuit water pressure	Current value		bar			
*If no system control is installed, the menu item is displayed in the product's control panel.						

Setting level	Values		Unit	Increment, select	Factory setting	Setting
	Min.	Max.				
<b>Building circuit flow rate</b>	Current value		l/h			
<b>Compressor anti-cycling time</b>	Current value		min			
<b>Immersion heater anti-cycling time</b>	Current value		min			
<b>Target flow temp.</b>	Current value		°C			
<b>Current flow temp.</b>	Current value		°C			
<b>Energy integral</b>	Current value		°min			
<b>Cooling capacity</b>	Current value		kW			
<b>Electrical power consumption</b>	Current value		kW	Total power consumption of the heat pump without any external components connected (as supplied).		
<b>Compressor modulation</b>	Current value		%			
<b>Air inlet temperature</b>	Current value		°C			
<b>Immersion heater power</b>	Current value		kW			
<b>Outdoor temperature</b>	Current value		°C			
<b>Information →</b>						
<b>Contact details</b>	Phone number					
<b>Serial number</b>	Permanent value					
<b>Operating hours total</b>	Cumulative value		h			
<b>Hours heating</b>	Cumulative value		h			
<b>DHW operating hours</b>	Cumulative value		h			
<b>Cooling op. hours</b>	Cumulative value		h			
<b>Default settings →</b>						
<b>Language</b>	Current language			Languages available for selection	02 English	
<b>Display contrast</b>	Current value			1	25	
	15	40				
<b>Resets →</b>						
<b>Reset anti-cycling time</b>						
<b>No sub-items available</b>						
*If no system control is installed, the menu item is displayed in the product's control panel.						

# Installation instructions

## Contents

<b>1</b>	<b>Safety</b> .....	<b>15</b>	7.9	Checking the heating mode .....	22
1.1	Action-related warnings .....	15	7.10	Checking the domestic hot water generation .....	22
1.2	Intended use .....	15	7.11	Floor drying .....	22
1.3	General safety information .....	15	7.12	Starting up the optional system control .....	23
1.4	Regulations (directives, laws, standards) .....	16			
<b>2</b>	<b>Notes on the documentation</b> .....	<b>17</b>	<b>8</b>	<b>Adapting the unit to the heating installation</b> .....	<b>23</b>
2.1	Observing other applicable documents .....	17	8.1	Configuring the heating installation .....	23
2.2	Storing documents .....	17	8.2	Total pressure losses in the system .....	23
2.3	Validity of the instructions .....	17	8.3	Instructing the end user .....	23
2.4	Further information .....	17	<b>9</b>	<b>Troubleshooting</b> .....	<b>23</b>
<b>3</b>	<b>Product overview</b> .....	<b>17</b>	9.1	Contacting your service partner .....	23
3.1	Heat pump system .....	17	9.2	Reading off the fault codes .....	23
3.2	Overview of functional elements .....	17	9.3	Querying the fault memory .....	24
3.3	Connecting the power supply cable and eBUS cable in the system .....	17	9.4	Displaying Live Monitor (status codes) .....	24
3.4	CE marking .....	18	9.5	Using the function menu .....	24
3.5	Safety devices .....	18	9.6	Carrying out the actuator test .....	24
3.6	Energy balance control .....	18	9.7	Resetting parameters to factory settings .....	24
3.7	Compressor hysteresis .....	18	<b>10</b>	<b>Inspection and maintenance</b> .....	<b>24</b>
3.8	Cooling mode .....	18	10.1	Checking maintenance messages .....	24
<b>4</b>	<b>Set-up</b> .....	<b>18</b>	10.2	Using check programmes .....	24
4.1	Checking the scope of delivery .....	18	<b>11</b>	<b>Decommissioning</b> .....	<b>24</b>
4.2	Selecting the installation site .....	18	11.1	Decommissioning the product .....	24
4.3	Opening the housing .....	18	<b>12</b>	<b>Recycling and disposal</b> .....	<b>24</b>
4.4	Installing the product .....	19	<b>13</b>	<b>Customer service</b> .....	<b>25</b>
4.5	Closing the casing .....	19	<b>Appendix</b> .....	<b>26</b>	
<b>5</b>	<b>Electrical installation</b> .....	<b>19</b>	<b>A</b>	<b>Printed circuit board</b> .....	<b>26</b>
5.1	Installing the VR 10 standard sensor .....	19	<b>B</b>	<b>Basic connection diagram for the energy supply company lockout</b> .....	<b>27</b>
5.2	Installing the outdoor temperature sensor .....	19	<b>C</b>	<b>Installer level overview</b> .....	<b>28</b>
5.3	Preparing the electrical installation .....	19	<b>D</b>	<b>Status codes</b> .....	<b>31</b>
5.4	Installing components for the energy supply company lockout function .....	20	<b>E</b>	<b>Maintenance messages</b> .....	<b>33</b>
5.5	Connecting the circulation pump .....	21	<b>F</b>	<b>Fault codes</b> .....	<b>34</b>
5.6	Connecting a limit thermostat for the underfloor heating .....	21	<b>G</b>	<b>Characteristic values for the internal temperature sensors, hydraulic circuit</b> .....	<b>38</b>
5.7	Connecting the outdoor temperature sensor .....	21	<b>H</b>	<b>Characteristic values for the VRC DCF outdoor temperature sensor</b> .....	<b>38</b>
5.8	Connecting the external prioritising diverter valve (optional) .....	21	<b>I</b>	<b>Technical data</b> .....	<b>39</b>
5.9	Connecting the <b>VR 70/VR 71</b> mixer module .....	21	<b>Index</b> .....	<b>40</b>	
<b>6</b>	<b>Operation</b> .....	<b>21</b>			
6.1	Operating concept of the product .....	21			
<b>7</b>	<b>Start-up</b> .....	<b>21</b>			
7.1	Starting up the product .....	21			
7.2	Switching on the product .....	21			
7.3	Running the installation assistants .....	21			
7.4	Menu functions without the optional system control .....	22			
7.5	Calling up the installer level .....	22			
7.6	Checking the configuration .....	22			
7.7	Calling up statistics .....	22			
7.8	Displaying the filling pressure in the building circuit .....	22			

# 1 Safety

## 1.1 Action-related warnings

### Classification of action-related warnings

The action-related warnings are classified in accordance with the severity of the possible danger using the following warning symbols and signal words:

#### Warning symbols and signal words

**Danger!**

Imminent danger to life or risk of severe personal injury

**Danger!**

Risk of death from electric shock

**Warning.**

Risk of minor personal injury

**Caution.**

Risk of material or environmental damage

## 1.2 Intended use

There is a risk of injury or death to the user or others, or of damage to the product and other property in the event of improper use or use for which it is not intended.

This product is a system component for controlling the heating circuits and domestic hot water generation in conjunction with a heat pump using a system control.

The product is intended exclusively for domestic use.

The intended use only allows for these product combinations:

Outdoor unit	Heat pump control module
VWL ..5/6 A ..	VWZ AI

- observance of accompanying operating, installation and maintenance instructions for the product and any other system components
- installing and setting up the product in accordance with the product and system approval
- compliance with all inspection and maintenance conditions listed in the instructions.

Intended use also covers installation in accordance with the IP code.

Any other use that is not specified in these instructions, or use beyond that specified in this document, shall be considered improper use. Any direct commercial or industrial use is also deemed to be improper.

**Caution.**

Improper use of any kind is prohibited.

## 1.3 General safety information

### 1.3.1 Risk caused by inadequate qualifications

The following work must only be carried out by competent persons who are sufficiently qualified to do so:

- Set-up
  - Dismantling
  - Installation
  - Start-up
  - Inspection and maintenance
  - Repair
  - Decommissioning
- ▶ Proceed in accordance with current technology.

### 1.3.2 Risk of death from electric shock

There is a risk of death from electric shock if you touch live components.

Before commencing work on the product:

- ▶ Disconnect the product from the power supply by switching off all power supplies at all poles (electrical partition in over-voltage category III for full partition, e.g. fuse or circuit breaker).
- ▶ Secure against being switched back on again.
- ▶ Wait for at least 3 minutes until the capacitors have discharged.
- ▶ Check that there is no voltage.

### 1.3.3 Material damage due to unsuitable installation room

If you are installing the product in a moist environment, the electronics may be damaged by moisture.

- ▶ Only install the product in dry rooms.



### **1.3.4 Risk of material damage due to malfunctioning**

Not rectifying faults, changing the safety devices and failing to carry out maintenance can cause malfunctioning and pose safety risks during operation.

- ▶ Ensure that the heating installation is in a technically perfect condition.
- ▶ Ensure that no safety or monitoring devices have been removed, bridged or disabled.
- ▶ Immediately eliminate any faults and damage that may affect safety.

### **1.3.5 Danger due to error functions**

- ▶ Ensure that the heating system is in a technically perfect condition.
- ▶ Ensure that no safety or monitoring devices have been removed, bridged or disabled.
- ▶ Immediately rectify any faults and damage that may affect safety.
- ▶ At lengths of over 10 m, 230 V supply lines must be laid separately from sensor or bus lines.
- ▶ Secure all supply lines in the casing using the cable terminals.
- ▶ Do not use the unit's free terminals as supports for other wiring.

### **1.3.6 Risk of material damage caused by using an unsuitable tool**

- ▶ Use the correct tool.

## **1.4 Regulations (directives, laws, standards)**

- ▶ Observe the national regulations, standards, directives, ordinances and laws.





## 2 Notes on the documentation

### 2.1 Observing other applicable documents

- ▶ Always observe all the operating and installation instructions included with the system components.

### 2.2 Storing documents

- ▶ Pass these instructions and all other applicable documents on to the end user.

### 2.3 Validity of the instructions

These instructions apply only to:

Product
VWZ AI

### 2.4 Further information



- ▶ Scan the displayed code using your smartphone in order to view further information about the installation.
  - ◀ You are guided to installation videos.

## 3 Product overview

### 3.1 Heat pump system

Design of a sample heat pump system with monoblock technology:

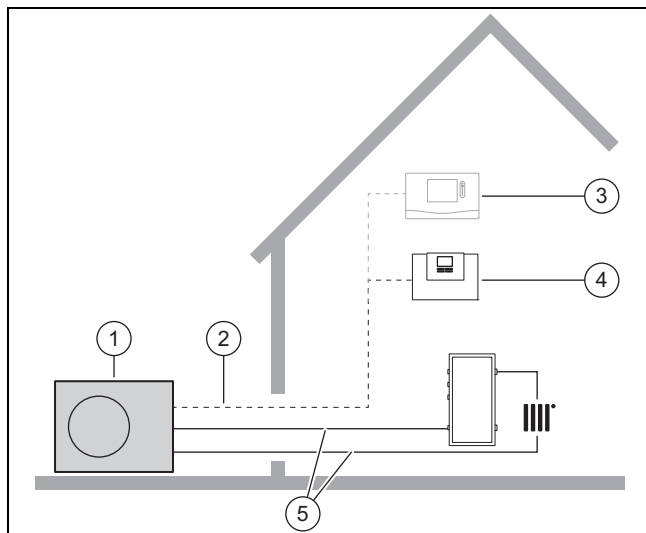

- |                             |                            |
|-----------------------------|----------------------------|
| 1 Heat pump, outdoor unit   | 4 Heat pump control module |
| 2 eBUS line                 | 5 Heating circuit          |
| 3 System control (optional) |                            |

### 3.2 Overview of functional elements

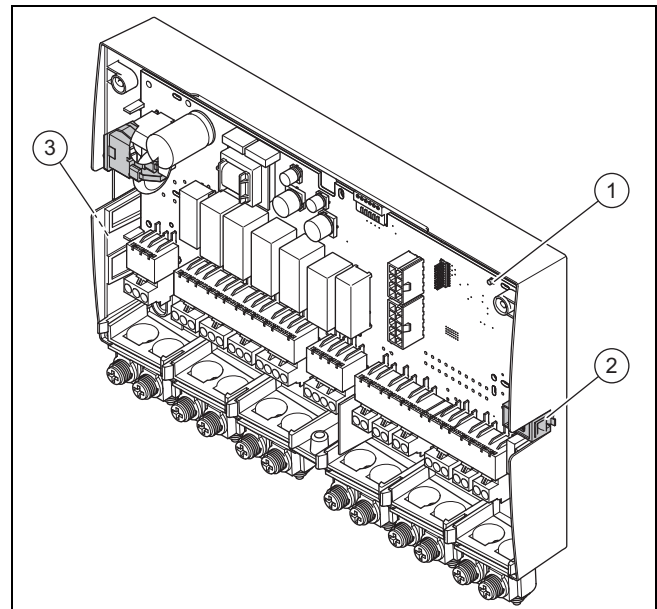

- |                                     |                        |
|-------------------------------------|------------------------|
| 1 LED                               | 3 Identification plate |
| 2 Diagnostic socket (for later use) |                        |

### 3.3 Connecting the power supply cable and eBUS cable in the system

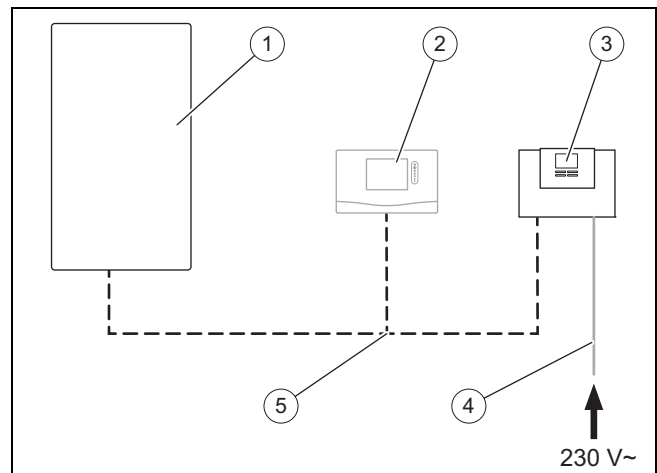

- |                  |                                      |
|------------------|--------------------------------------|
| 1 Heat pump      | 4 230 V power supply cable (on-site) |
| 2 System control | 5 eBUS cable                         |
| 3 VWZ AI         |                                      |

The product is connected to the power supply on-site. You can branch the eBUS connection to the product at any part of the eBUS system.

### 3.4 CE marking



The CE marking shows that the products comply with the basic requirements of the applicable directives as stated on the declaration of conformity.

The declaration of conformity can be viewed at the manufacturer's site.

### 3.5 Safety devices

#### 3.5.1 Frost protection function

The frost protection function for the system is controlled using the product itself or using the optional system control. If the system control fails, the product guarantees limited frost protection for the heating circuit.

At negative outdoor temperatures, there is an increased risk of the heating water freezing if a heat pump fault occurs, e.g. due to a power cut or a defective compressor.

#### 3.5.2 Low-water pressure protection

This function continuously monitors the pressure of the heating water in order to prevent a possible loss of heating water. If the water pressure falls below the minimum pressure, an analogue pressure sensor switches the product off and, if available, switches other modules to standby mode. If the water pressure reaches the operating pressure, the pressure sensor switches the product back on.

If the heating water pressure falls below  $\leq 0.1$  MPa (1 bar), a maintenance message appears below the display of the minimum operating pressure.

- Min. heating circuit pressure:  $\geq 0.05$  MPa ( $\geq 0.50$  bar)
- Min. heating circuit operating pressure:  $\geq 0.07$  MPa ( $\geq 0.70$  bar)

### 3.6 Energy balance control

The energy balance is the integral from the difference between the flow temperature actual value and target value, which is added up every minute. If the set heat deficit is reached, the heat pump starts. If the supplied heat volume corresponds to the heat deficit, the heat pump is switched off.

The energy balancing is used for heating and cooling mode.

### 3.7 Compressor hysteresis

The heat pump is switched on and off via the compressor hysteresis for heating mode and also for energy balancing. When the compressor hysteresis is above the target flow temperature, the heat pump is switched off. When the hysteresis is below the target flow temperature, the heat pump starts up again.

### 3.8 Cooling mode

## 4 Set-up

### 4.1 Checking the scope of delivery

- ▶ Check that the scope of delivery is complete.

Quantity	Designation
1	VWZ AI
2	VR 10 standard sensor
1	Installation accessories (screws and wall plugs)
1	Installation instructions

### 4.2 Selecting the installation site

- ▶ The installation site must be below 2000 metres above sea level.
- ▶ Select a dry room that is frost-proof throughout and in which the maximum installation height is not exceeded and the environmental temperature is neither above nor below the permitted range.
  - Permissible environmental temperature: 7 to 25 °C
  - Permissible relative air humidity: 40 to 75 %
- ▶ Ensure that the required minimum clearances can be maintained.

### 4.3 Opening the housing

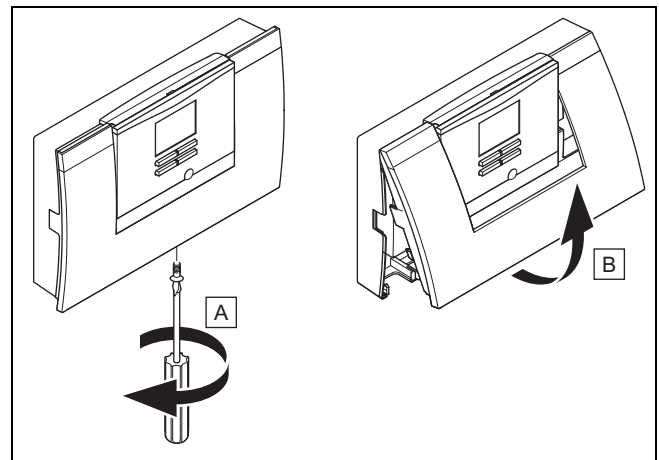

1. Unscrew the bolt from the underside of the casing.
2. Pull the casing cover slightly forwards at the lower edge.
3. Lift the casing cover upwards.

## 4.4 Installing the product

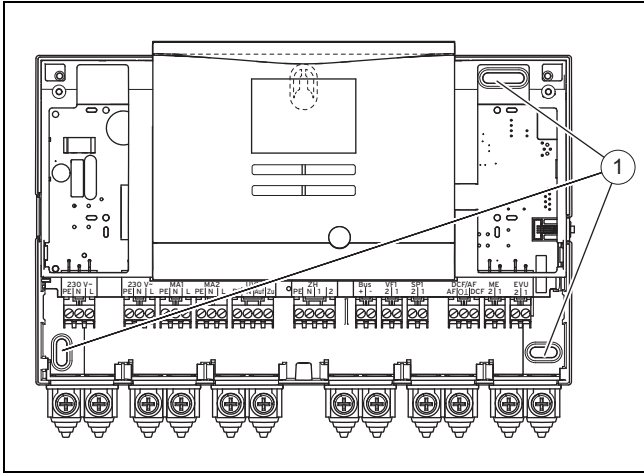

1. Mount the product and the supplied installation accessory on the wall. Use the fixing points (1) for this.
2. Connect the product. (→ Page 20)

## 4.5 Closing the casing

1. Insert the casing cover at the top into the hinges.
2. Fold down the casing cover.
3. Tighten the bolt on the underside of the casing.

## 5 Electrical installation

Only qualified electricians may carry out the electrical installation.

### 5.1 Installing the VR 10 standard sensor



#### Note

You can use the VR 10 as a cylinder temperature sensor (for example, as an immersion sensor in a cylinder dry pocket), as a flow temperature sensor (for example, in the low loss header) or as a surface-mounted sensor. We recommend that the pipe with the sensor be insulated to ensure optimum temperature recording.

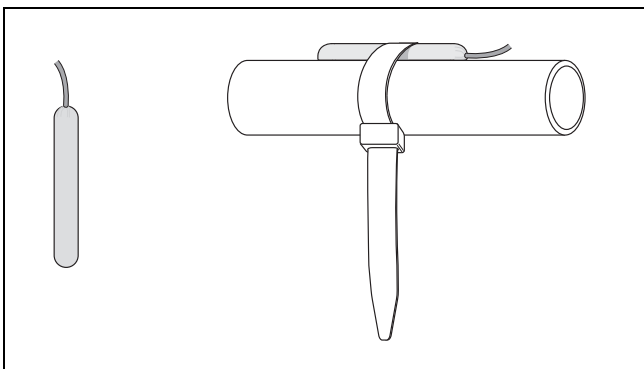

- If you use the VR 10 as a surface-mounted sensor, secure the VR 10 to a return/flow pipe using the enclosed strap.

## 5.2 Installing the outdoor temperature sensor

### Installing the outdoor temperature sensor

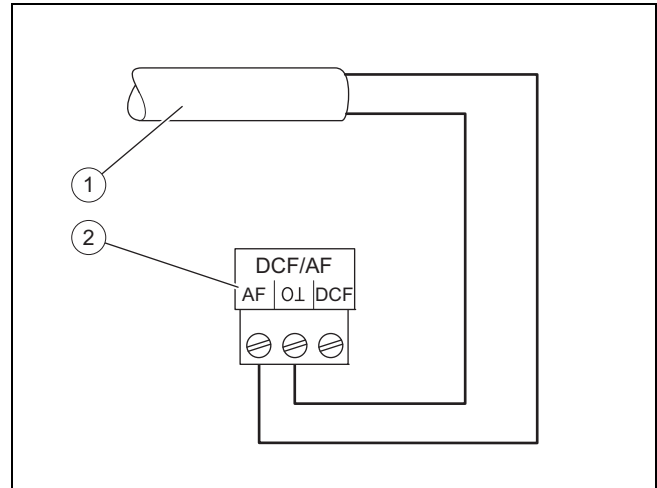

- 1 Connection cable to the VRC 693 external temperature sensor
- 2 Connector in the product

- Install the outdoor temperature sensor in accordance with its enclosed set-up instructions.

### 5.3 Preparing the electrical installation



#### Danger!

**Risk of death from electric shock as a result of an improper electrical connection!**

An improper electrical connection may negatively affect the operational safety of the product and result in material damage or personal injury.

- Only carry out the electrical installation if you are a trained competent person and are qualified for this work.

1. Observe the technical connection conditions for connecting to the energy supply company's low-voltage network.
2. Use the data plate to determine whether the product requires a 1~/230V or a 3~/400V electrical connection.
3. If the local power supply network operator requires that the heat pump is controlled using an ESCO blocking signal, install a corresponding contact switch as prescribed by the power supply network operator.
4. Determine whether the power supply for the product should be set up with a single-tariff meter or a dual-tariff meter.
5. Connect the product via a fixed connection and a partition with a contact gap of at least 3 mm.
6. Leave the cable cross-section for the connection cable to the distribution box unchanged.
7. If the power supply cable for this product is damaged, it must be replaced by the manufacturer or their customer service or a similarly qualified person in order to prevent any hazards.
8. Ensure that the nominal voltage of the power grid corresponds to that of the product's main power supply cabling.
9. Make sure that access to the power supply is always available and is not covered or blocked.

- Determine whether the energy supply company lockout function has been provided for the product, and how the power supply for the product should be designed, depending on the type of shutdown.

### 5.3.1 Carrying out the wiring

- Ensure that the mains voltage is correctly disconnected from the safety extra-low voltage.
- Only connect power supply cables to the terminals that are marked for the purpose.
- Shorten the connection cables according to requirements.

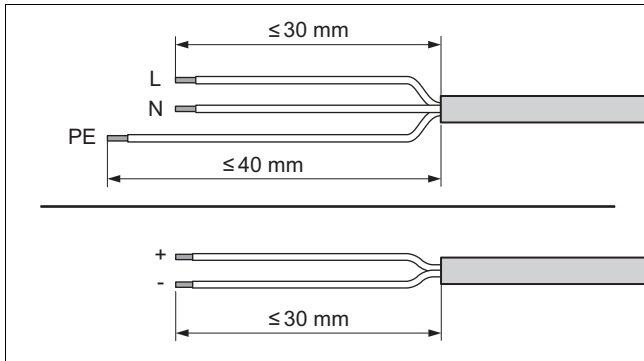

- Strip the electrical wire as shown in the figure. In doing so, ensure that the insulation on the individual conductors is not damaged.
- Ensure the inner conductor insulation is not damaged when stripping the outer sheathing.
- Only strip inner conductors just enough to establish good, sound connections.
- Fit conductor end sleeves on the stripped ends of the conductors.
- Screw the respective plug to the connection cable.
- Check whether all conductors are inserted mechanically securely in the plug terminals. Remedy this if necessary.
- Plug the plug into the associated PCB slot.

### 5.3.2 Requirements for the eBUS line

Observe the following rules when routing the eBUS lines:

- ▶ Use twin-core cables.
- ▶ Never use shielded or twisted cables.
- ▶ Use only appropriate cables, e.g. NYM or H05VV (-F/-U).
- ▶ Observe the permissible total length of 125 m. For a total length of up to 50 m, a conductor cross-section of  $\geq 0.75 \text{ mm}^2$  applies; from 50 m upwards, a conductor cross-section of  $1.5 \text{ mm}^2$  applies.

In order to prevent faults in the eBUS signals (e.g. due to interferences):

- ▶ Maintain a minimum clearance of 120 mm to power supply cables or other electromagnetic sources of interference.
- ▶ For parallel routing to mains connection lines, guide the cables in accordance with the applicable regulations, e.g. on cable trays.
- ▶ **Exceptions:** For wall breaks and in the electronics box, it is acceptable to not reach the minimum clearance.

### 5.3.3 Requirements for the quality of the mains voltage

For the mains voltage of the single-phase 230 V network, a tolerance of +10% to -15% must be provided.

### 5.3.4 Connecting the product



#### Note

The power supply cable and the eBUS line are not included in the scope of delivery.

- Connect the product using a fixed connection and a partition with a contact gap of at least 3 mm (e.g. fuses or power switches).
- Wire the product in accordance with the wiring diagram; see appendix.



#### Note

If the diverter valve should be in the position for cylinder charging, 230 V is output to the "Open" contact. If the diverter valve should not be in the position for cylinder charging, 230 V is output to the "Closed" contact.



#### Note

The ESCO contact is used to connect a blocking signal (can be configured on the control).

Contact open: Operation permitted

Contact closed: Operation blocked

- Secure all lines in the product using the enclosed strain reliefs.
- Close the casing. (→ Page 19)

### 5.4 Installing components for the energy supply company lockout function

**Condition:** Energy supply company lockout function provided

The heat generation from the heat pump can be switched off temporarily by the energy supply company – usually by using a ripple control receiver.

The signal for the shutdown is fed to connection *ESCO* for the heat pump control module.

- ▶ Install and wire additional components in the building's meter/fuse box. To do this, follow the wiring diagram in the appendix.



#### Note

In the event of control via connection *ESCO*, the energy supply does not have to be disconnected on-site.

- ▶ Connect a 2-pole control cable to the relay contact (potential-free) for the ripple control receiver and to connection *ESCO*.
- ▶ In the system control, set whether the electric back-up heater, the compressor or both should be blocked via *ESCO*.

## 5.5 Connecting the circulation pump

1. Guide the circulation pump's 230 V connection cable from the bottom left-hand side and into the electronics box.
2. Connect the 230 V connection cable to the plug from slot *MO2* and plug it into the slot.
3. Connect the connection cable for the external button using terminals 1 (0) and 2 (FB) on the *MI* edge connector, which is supplied with the control.
4. Plug the edge connector into the *MI* slot.
5. Set the circulation pump in the system control.

## 5.6 Connecting a limit thermostat for the underfloor heating

- ▶ Connect the limit thermostat to plug *S20* for the outdoor unit, → aroTHERM plus operating and installation instructions.

## 5.7 Connecting the outdoor temperature sensor

**Condition:** No system control connected

- ▶ Connect a *DCF/AF* outdoor temperature sensor to the terminals for plug *DCF/AF* and plug it into the slot.

## 5.8 Connecting the external prioritising diverter valve (optional)

- ▶ Connect the external prioritising diverter valve to the *UV1* plug terminal and plug it into the slot.
  - The connection to a permanently live phase "L" with 230 V and to a switched phase "S" is available. Phase "S" is actuated by an internal relay and releases 230 V.

## 5.9 Connecting the VR 70/VR 71 mixer module

1. Connect the power supply for the **VR 70/VR 71** mixer module to *X4* on the PCB.
2. Connect the **VR 70/VR 71** mixer module to the eBUS.

# 6 Operation

## 6.1 Operating concept of the product

The operating concept and the read-out and setting options of the end user level are described in the operating instructions.

# 7 Start-up

## 7.1 Starting up the product

1. Ensure that the casing is closed when starting up the product.
2. Start up the product together with the controller (→ Installation instructions for the controller).

## 7.2 Switching on the product



### Note

The product does not have an on/off switch. The product is switched on as soon as it is connected to the power grid.

1. Use the partition that is installed on-site to switch the product on.
  - ◁ The display shows the basic display.
  - ◁ The basic display appears on the system control display.
  - ◁ The system's products start up.
  - ◁ The heating and domestic hot water demand are activated by default.
2. When you start up the heat pump system for the first time after electrical installation, the installation assistants for the system components will start automatically. Set the required values on the control panel of the control module first, then on the optional system control and the other system components.

## 7.3 Running the installation assistants

The installation assistant is launched when the product is switched on for the first time. It provides direct access to the most important check programmes and configuration settings for starting up the product.

Confirm the launch of the installation assistant. All heating and domestic hot water demands are blocked whilst the installation assistant is active.

Set the following parameters:

- Language
- System control present
- Cooling technology
- Compressor current limit
- Relay multi-function output
- Intermediate heat exchanger present
- Check programme: Purge building circuit
- Contact details, Telephone number

To access the next item, confirm by pressing **Next** in each case.

If you do not confirm the launch of the installation assistant, it is closed 10 seconds after you switch on the unit and the basic display then appears. If the installation assistant does not run through completely, it restarts the next time the unit is switched on.

### 7.3.1 Ending the installation assistant

- ▶ Once you have run through the installation assistant successfully, confirm by pressing .
- ◀ The installation assistant will close and will not launch again when the product is next switched on.





### 7.4 Menu functions without the optional system control

If no system control is installed and this has been confirmed in the installation assistant, the following additional functions are displayed in the product's control panel:

- End user level
  - Room temperature setpoint
  - Screed drying activ.
  - Target cylinder temp.
  - Domestic hot water cylinder temp.
  - Manual cooling activation
- Installer level
  - Heat curve
  - Summer sw.-off temp.
  - Heating biv. point
  - DHW bivalence point
  - Heating alt. point
  - Max. flow temperature
  - Min. flow temperature
  - Heating mode activ.
  - DHW activation
  - Cyl. charg. hysteresis
  - Limp home mode Immersion heater: Heating/DHW
  - Cooling target flow
  - Screed drying day

If the system control has been retroactively removed or a defect is present, you must reset the product to the factory setting and select the system control in the installation assistant in order to obtain the additional functions in the product's control panel.

### 7.5 Calling up the installer level

1. Press  and  at the same time.
2. Navigate to **Menu** → **Installer level** and confirm by pressing  (OK).
3. Set the value **17** and confirm by pressing .

### 7.6 Checking the configuration

You can recheck and set the most important system parameters. Call up **Configuration** to configure the menu item.

**Menu** → **Installer level** → **Configuration**.

### 7.7 Calling up statistics

**Menu** → **Installer level** → **Test menu** → **Statistics**

You can use this function to call up the statistics for the heat pump.

### 7.8 Displaying the filling pressure in the building circuit

The product has a pressure sensor in the heating circuit and a digital pressure display.

- ▶ Select **Menu Live Monitor** to display the filling pressure in the building circuit.

### 7.9 Checking the heating mode

- ▶ Start check programme P.04.

### 7.10 Checking the domestic hot water generation

- ▶ Check whether the cylinder is purged and the domestic hot water temperature is reached.

### 7.11 Floor drying



#### Caution.

#### Risk of damage to the product caused by impermissible purging

Without purging the heating circuit, the system may become damaged.

- ▶ If the screed drying is activated without a system control, purge the system manually. No automatic purging takes place.

- You can use this function to "dry heat" freshly laid screed in accordance with the construction regulations, according to a defined time and temperature schedule, without the need for a system control to be connected.

If there is no electric back-up heater, screed drying is only possible with this product if the return temperature is above 10 °C. This corresponds approximately to an outdoor temperature of +5 °C. At outdoor temperatures below +5 °C, there is a risk of increased icing of the fin-type heat exchanger in the outdoor unit.

When screed drying is activated, all the selected operating modes are interrupted. The function controls the flow temperature of the controlled heating circuit according to a pre-set programme, regardless of the outdoor temperature.

The display shows the target flow temperature. You can manually set the current day.

Days after starting the function	Target flow temperature for this day [°C]
1	25
2	30
3	35
4	40
5	45
6-12	45
13	40
14	35
15	30



Days after starting the function	Target flow temperature for this day [°C]
16	25
17–23	10 (frost protection function, pump in operation)
24	30
25	35
26	40
27	45
28	35
29	25

The day is always changed at 00:00, irrespective of when the function starts.

After a mains Off/On, screed drying starts with the last active day.

The function ends automatically when the last day of the temperature profile has elapsed (day = 29) or if you set the start day to 0 (day = 0).

### 7.12 Starting up the optional system control

The following work for starting up the system was carried out:

- The system control and the outdoor temperature sensor have been installed and wired.
- Start-up of all system components (except for the system control) is complete.

Follow the installation assistant and the operating and installation instructions for the system control.

## 8 Adapting the unit to the heating installation

### 8.1 Configuring the heating installation

To adjust the water flow rate that is created by the heat pump to the relevant installation, the maximum available remaining feed head can be set for the heat pump in heating and domestic hot water mode and the output of the building circuit pump for heating, cooling and domestic hot water.

Since the heat pump installation regulates the building circuit pump at the nominal flow in automatic mode, only set the parameters where required.

You can call up these parameters via **Menu** → **Installer level** → **Configuration**.

The adjustment range for the remaining feed head is between 20 kPa (200 mbar) and 90 kPa (900 mbar). The heat pump operates at its optimum level when the nominal flow can be achieved by setting the available pressure (Delta T = 5 K).

### 8.2 Total pressure losses in the system

→ See installation instructions for the outdoor unit

### 8.3 Instructing the end user



#### Danger!

#### Risk of death from legionella.

Legionella multiply at temperatures below 60 °C.

- ▶ Ensure that the end user is familiar with all of the Anti-legionella measures in order to comply with the applicable regulations regarding legionella prevention.

- ▶ Explain to the end user how the safety devices work and where they are located.
- ▶ Inform the end user about all of the anti-legionella measures.
- ▶ Inform the end user how to handle the product.
- ▶ Draw particular attention to the safety warnings, which the end user must follow.
- ▶ Inform the end user that they must have the product maintained in accordance with the specified intervals.
- ▶ Explain to the end user how to check the system's water volume/filling pressure.
- ▶ Pass all of the instructions and documentation for the product to the end user for safe-keeping.

## 9 Troubleshooting

### 9.1 Contacting your service partner

If you contact your service partner, please mention if possible:

- The fault code that is displayed (**F.xx**)
- The status code (**S.xx**) that is displayed by the product in the Live Monitor

### 9.2 Reading off the fault codes

If a fault develops in the product, the display shows a fault code **F.xx**.

Fault codes have priority over all other displays.

If multiple faults occur at the same time, the display shows the corresponding fault codes for two seconds each in sequence.



- ▶ Eliminate the fault.
- ▶ To start up the product again, press the reset button ( Operating instructions).
- ▶ If you are unable to eliminate the fault and the fault recurs despite several reset attempts, contact Customer Service.

### 9.3 Querying the fault memory

The product has a fault memory. You can use this to query the last ten faults that occurred in chronological order.

To call up the fault memory, select **Menu** → **Installer level** → **List of faults**.

The display shows:

- Number of faults that occurred
  - The fault that is currently selected with fault number **F.xx**
  - A plain text display explaining the fault.
- ▶ Use the  or  button to display the last ten faults that occurred.

### 9.4 Displaying Live Monitor (status codes)

Status codes in the display provide information on the product's current operating mode. These can be called up via the **Live Monitor** menu.

### 9.5 Using the function menu

You can use the function menu to actuate and test individual components of the product during the fault diagnostics. (→ Page 24)

### 9.6 Carrying out the actuator test

**Menu** → **Installer level** → **Test menu** → **Sensor/actuator test**

You can check that the components of the heating installation are functioning correctly using the sensor/actuator test. You can actuate more than one actuator at a time.

If you do not select anything to change, you can have the current control values for the actuators and the sensor values displayed.

You can find a list of the sensor characteristic values in the appendix.

Characteristic values for the internal temperature sensors, hydraulic circuit (→ Page 38)

Characteristic values for the VRC DCF outdoor temperature sensor (→ Page 38)

### 9.7 Resetting parameters to factory settings

- ▶ Select **Menu** → **Menu** → **Installer level** → **Resets** to reset all of the parameters at the same time and to restore the product to the factory settings.

## 10 Inspection and maintenance

### 10.1 Checking maintenance messages

If the  symbol is shown in the display, the product requires maintenance work or the product is in comfort protection mode.

- ▶ To obtain further information, call up the **Live Monitor**.
- ▶ Carry out the maintenance work that is listed in the table.

Maintenance messages (→ Page 33)

**Condition:** Lhm.XX is displayed

The product is in Comfort protection mode. The product has detected a permanent fault and continues to run with restricted comfort.

- ▶ To determine which component is defective, read the fault memory (→ Page 24).



#### Note

If a fault message is present, the product remains in comfort protection mode after it is reset. After the product is reset, the fault message is displayed first before the message **Limp home mode (comfort protection)** appears again.

- ▶ Check the component that is displayed and replace it, if required.

### 10.2 Using check programmes

You can call up the check programmes via **Menu** → **Installer level** → **Test menu** → **Check programme**.

If the product is in error condition, you cannot start any check programmes. You can detect an error condition by the fault symbol shown in the left bottom corner of the display. You must first reset.

To end the check programmes, you can press **Cancel** at any time.

## 11 Decommissioning

### 11.1 Decommissioning the product

- ▶ Disconnect the product from the power grid.
- ▶ Disconnect the sensor cable and eBUS cable.

## 12 Recycling and disposal

### Packaging

- ▶ Dispose of the packaging correctly.

This product is an electrical or electronic unit within the context of EU Directive 2012/19/EU. The unit was developed and manufactured using high-quality materials and components. These can be recycled and reused.

Find out about the regulations that apply in your country regarding the separate collection of waste electrical or electronic equipment. Correctly disposing of old units protects the environment and people against potential negative effects.

- ▶ Dispose of the packaging correctly.
- ▶ Observe all relevant regulations.

### Disposing of the product



■ If the product is labelled with this symbol:

- ▶ In this case, do not dispose of the product with the household waste.
- ▶ Instead, hand in the product to a collection centre for waste electrical or electronic equipment.



## Disposing of batteries



■ If the product contains batteries that are labelled with this symbol:

- ▶ In this case, dispose of the batteries at a collection point for batteries.
  - ◁ **Prerequisite:** The batteries can be removed from the product without causing any destruction. Otherwise, the batteries are disposed of together with the product.
- ▶ In accordance with the legal regulations, the end user is obligated to return used batteries.

## Deleting personal data

Personal data may be misused by unauthorised third parties.

If the product contains personal data:

- ▶ Ensure that there is no personal data on or in the product (e.g. online login details or similar) before you dispose of the product.

## 13 Customer service

**Validity:** Great Britain AND Vaillant

For contact details for our customer service department, you can write to the address that is provided on the back page, or you can visit [www.vaillant.co.uk](http://www.vaillant.co.uk).

# Appendix

## A Printed circuit board

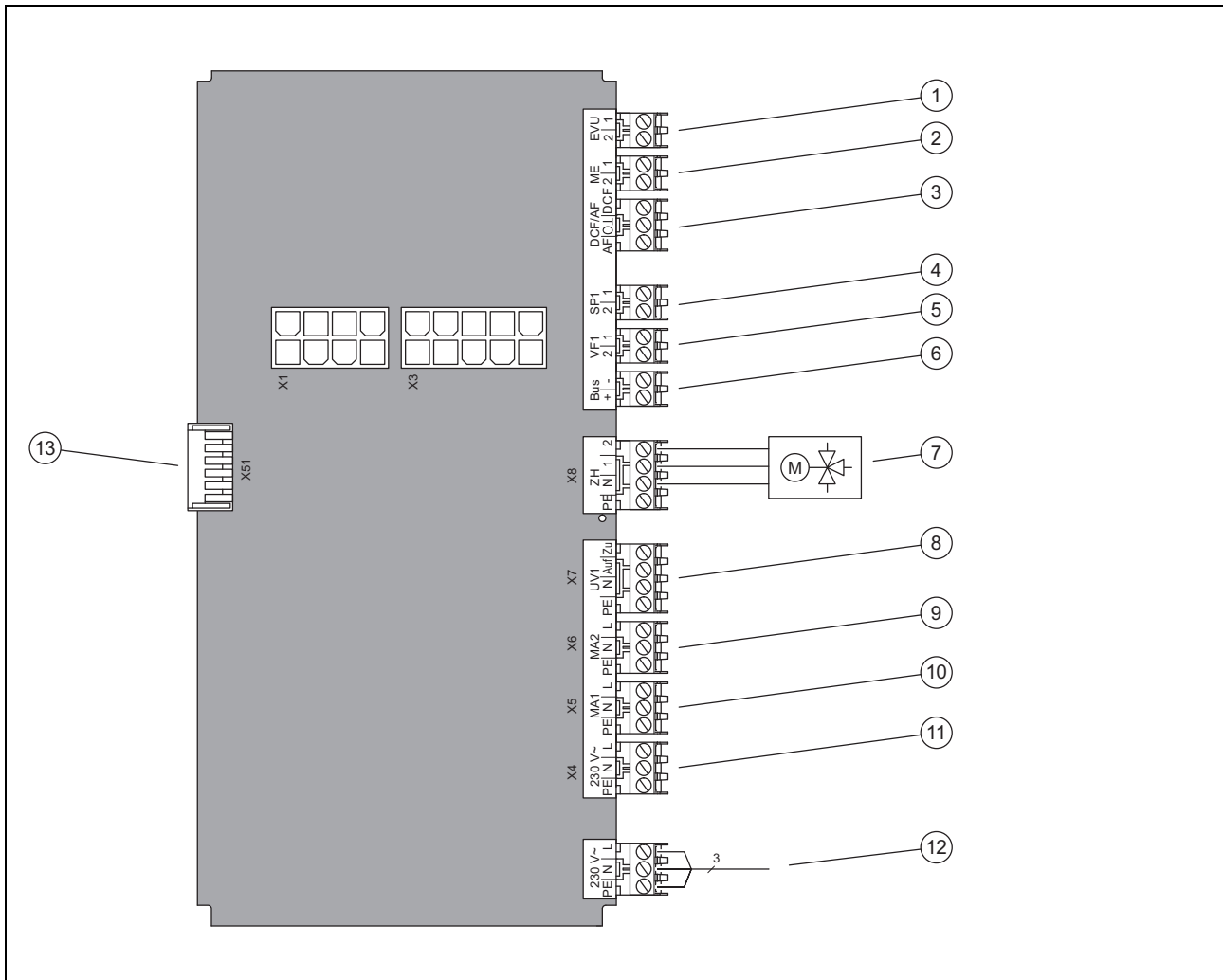

1	[ESCO] Energy supply company contact	8	[X7] UV1 external prioritising diverter valve
2	[MI] Multi-function input: Manual circulation switch-on	9	[X6] MA2 multi-function output 2: Circulation pump, anti-legionella pump, zone valve, dehumidifying unit
3	[DCF/AF] DCF/outdoor temperature sensor	10	[X5] MA1 multi-function output 1: Zone valve (basic system diagram 8), cooling signal (basic system diagrams 8, 9, 12), intermediate heat exchanger pump (basic system diagrams 10, 11, 13, 16)
4	[SP1] Domestic hot water cylinder temperature sensor	11	[X4] 230 V power supply for optional accessories
5	[VF1] System temperature sensor	12	230 V power supply
6	[BUS] eBUS bus connection (outdoor unit, system control)	13	[X51] Display edge connector
7	[X8] ZH external back-up heater or MEH 60		

## B Basic connection diagram for the energy supply company lockout

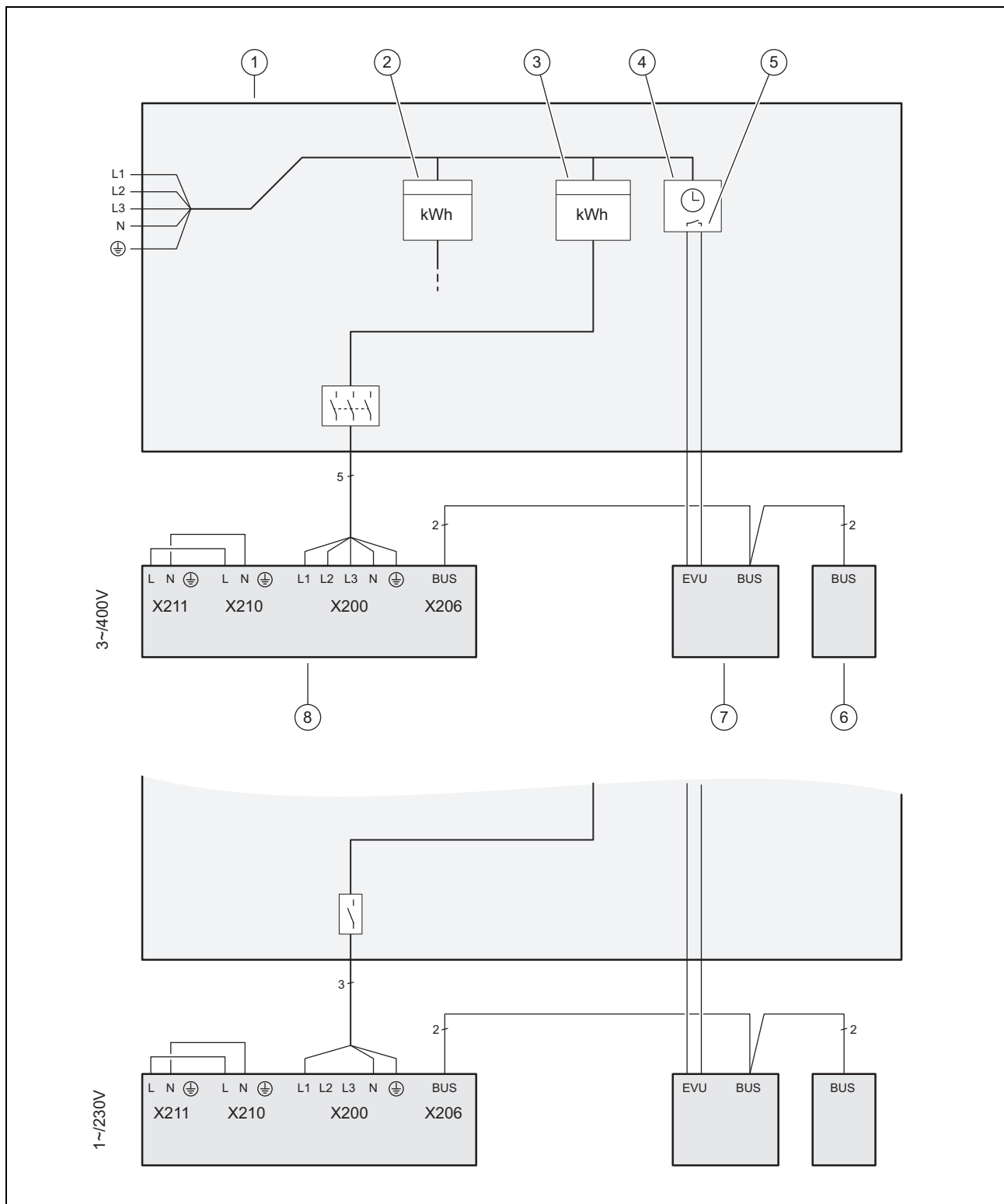

- |   |                             |   |  |
|---|-----------------------------|---|--|
| 1 | Meter/fuse box              | 5 | Potential-free normally open contact, for actuating ESCO, for the energy supply company lockout function |
| 2 | Household electricity meter | 6 | System control   |
| 3 | Heat pump electricity meter | 7 | Heat pump control module, PCB  |
| 4 | Ripple control receiver     | 8 | Outdoor unit, PCB INSTALLER BOARD  |

## C Installer level overview

Setting level	Values		Unit	Increment, select, explanation	Factory setting	Setting
	Min.	Max.				
<b>Installer level →</b>						
Enter code	00	99		1 (competent person code 17)	17	
<b>Installer level → Fault list →</b>						
F.XX – F.XX <sup>1)</sup>	Current value					
<b>Installer level → Test menu → Statistics →</b>						
Compressor hours	Current value		h			
Compressor starts	Current value					
Build. pump hours	Current value		h			
Build. pump starts	Current value					
4-port valve hours	Current value		h			
4-port valve sw. ops	Current value					
Fan 1 operating hours	Current value		h			
Fan 1 starts	Current value					
Fan 2 operating hours	Current value		h			
Fan 2 starts	Current value					
EEV steps	Current value					
No. switch. ops	Current value					
<b>Installer level → Test menu → Check programmes →</b>						
P.04 Heating mode				Select		
P.06 Purge building circuit				Select		
P.12 De-icing				Select		
P.27 Immersion heater				Select		
P.29 High pressure				Select		
<b>Installer level → Test menu → Sensor/actuator test →</b>						
T.0.01 Building circuit pump power	0	100	%	5, off	0	
T.0.17 Fan 1	0	100	%	5	0	
T.0.18 Fan 2	0	100	%	5	0	
T.0.19 Condensate tray heater	Off	On		On, Off	Off	
T.0.20 4-port valve	Off	On		On, Off	Off	
T.0.21 Position: EEV	0	100	%	5	0	
T.0.23 Heating coil compressor	Off	On		On, Off	Off	
T.0.40 Flow temperature	-40	90	°C	0.1		
T.0.41 Return temperature	-40	90	°C	0.1		
T.0.42 Building circuit water temperature	-40	90	°C	0.1		
T.0.43 Building circuit: Flow rate	0	4000	l/h	1		
T.0.48 Air inlet temperature	-40	90	°C	0.1		
T.0.55 Compressor outlet temperature	-40	135	°C	0.1		
<sup>1)</sup> See the overview of fault codes: Fault lists are only available, and can only be deleted, if faults have occurred. <sup>2)</sup> This parameter does not appear if a system control is connected. <sup>3)</sup> This parameter is only available in the products for Spain						

Setting level	Values		Unit	Increment, select, explanation	Factory setting	Setting
	Min.	Max.				
T.0.56 Compressor inlet temperature	-40	135	°C	0.1		
T.0.57 EEV outlet temperature	-40	90	°C			
T.0.59 Condenser outlet temperature	-40	90	°C	0.1		
T.0.63 High pressure	0	31.9	bar (abs)	0.1		
T.0.64 Low pressure	0	8	bar (abs)	0.1		
T.0.67 High-pressure switch	Closed	Open		Closed, Open		
T.0.85 Evaporation temperature	-40	90	°C	0.1		
T.0.86 Condensation temperature	-40	70	°C	0.1		
T.0.87 Overheating target value	-40	90	K	0.1		
T.0.88 Overheating actual value	-40	90	K	0.1 to 20 K are normal operating parameters		
T.0.89 Subcooling target value	-40	90	K	0.1		
T.0.90 Subcooling actual value	-40	90	K	0.1		
T.0.93 Compressor speed	0	120	Rotation/s	1		
T.0.123 Temperature switch: Compressor outlet	Open	Closed		Open, closed		
T.1.02 DHW prioritising diverter valve	Heating	Domestic hot water		Heating, domestic hot water	Heating	
T.1.44 Cylinder temperature	-40	90	°C	0.1		
T.1.46 Lockout contact S20	Closed	Open		Closed, Open	Closed	
T.1.69 Outdoor temperature	-40	90	°C	0.1		
T.1.70 System temperature	-40	90	°C	0.1		
T.1.71 DCF status	Current value			No DCF signal Validate DCF signal Valid DCF signal		
T.1.72 Lockout contact S21	Closed	Open		Closed, Open	Open	
T.1.119 MO1 output	Off	On		Off, On	Off	
T.1.125 MPI input	Current value					
T.1.126 MO2 output	Off	On		Off, On	Off	
<b>Installer level → Configuration →</b>						
Language	Current language			Languages available for selection	02 English	
Contact details → Telephone number	Phone number			0–9		
Heat curve <sup>2)</sup>	0.4	4.0		0.1		
Summer sw.-off temp. <sup>2)</sup>	10	90	°C	1		
Heating biv. point <sup>2)</sup>	-30	+20	°C	1		
DHW bivalence point <sup>2)</sup>	-20	+20	°C	1		
Heating alt. point <sup>2)</sup>	-20	+40	°C	Off 1		
Max. flow temperature <sup>2)</sup>	15	90	°C	1		
Min. flow temperature <sup>2)</sup>	15	90	°C	1		
Heating mode activ. <sup>2)</sup>				On Off		
DHW activation <sup>2)</sup>				On Off		
<sup>1)</sup> See the overview of fault codes: Fault lists are only available, and can only be deleted, if faults have occurred. <sup>2)</sup> This parameter does not appear if a system control is connected. <sup>3)</sup> This parameter is only available in the products for Spain						

Setting level	Values		Unit	Increment, select, explanation	Factory setting	Setting
	Min.	Max.				
<b>Cyl. charg. hysteresis</b> <sup>2)</sup>	3	20	K	1		
<b>Immers. heater mode</b> <sup>2)</sup>				Off Heating+DHW Heating Domestic hot water		
<b>Limp home mode</b> <sup>2)</sup>				Off Heating Domestic hot water Heating+domestic hot water		
<b>Cooling target flow</b> <sup>2)</sup>	7	24	°C	1		
<b>MO relay</b>				None Fault signal Ext. immersion heater DHW 3WV		
<b>Compr.start heat. from</b>	-999	9	°min	1	-60	
<b>Compr.start cool. from</b>	0	999	°min	1	60	
<b>Compressor hyster. Heat.</b>	0	15	K	Applies for heating mode only: 1	7	
<b>Compressor hyster. Cool.</b>	0	15	K	Applies for cooling mode only: 1	5	
<b>Max. rem. feed head</b>	200	900	mbar	10	900	
<b>DHW mode</b>	0 = ECO	2 = Balance		0 = ECO, 1 = Normal, 2 = Balance	0	
<b>Max. anti-cycl. time</b>	0	9	h	1	5	
<b>Conf. heat. build. pump</b>	50	100	% PWM	Auto	Auto	
<b>Conf. cool. build. pump</b>	50	100	% PWM	Auto	Auto	
<b>Conf. DHW build. pump</b>	50	100	% PWM	Auto	65	
<b>Reset anti-cycl. time → Anti-cycl. time after pow. supp. switch-on</b>	0	120	min	1	0	
<b>Compr. current limit</b>				1 5–7 kW: 13–16 A 12 kW: 20–25 A		
<b>Fan boost</b> <sup>3)</sup>	52	70		1	70	
<b>Compr. noise reduct.</b> <sup>2)</sup>	40	60	%	1	40	
Only for products with cooling: <b>Cooling technology</b>	None	Active cooling		None, active cooling	None	
<b>Intermediate heat exchanger</b>	Yes	no		Yes, No		
<b>Software version</b>	Current value of the control PCB (HMU indoor unit xxxx, HMU outdoor unit xxxx) and the display (AI xxxx)			xxxx.xx.xx		
<b>Installer level → Resets →</b>						
<b>Statistics → Reset statistics?</b>				Yes, No	No	
<b>Maintenance messages → Reset maintenance message</b>				Yes, No	No	
<b>High-pressure switch → Reset fault?</b>				Yes, No	No	
<sup>1)</sup> See the overview of fault codes: Fault lists are only available, and can only be deleted, if faults have occurred. <sup>2)</sup> This parameter does not appear if a system control is connected. <sup>3)</sup> This parameter is only available in the products for Spain						

Setting level	Values		Unit	Increment, select, explanation	Factory setting	Setting
	Min.	Max.				
Factory settings → Restore factory settings				Yes, No	No	
<b>Installer level → Start inst. assistant →</b>						
Language				Languages available for selection	02 English	
Syst. control avail.?	Yes	no		Yes, No		
Im. heater outp. range				2, 4, 6 kW, external		
Cooling technology	No cooling	Active cooling				
Compr. current limit	13	25	A	1 5–7 kW: 13–16 A 12 kW: 20–25 A		
Intermediate heat exchanger	Yes	no		Yes, No		
Check program: Purge building circuit	Yes	no		Yes, No	no	
Contact details Telephone number	Phone number			0–9	Empty	
End the installation assistant?				Yes, Back		
<sup>1)</sup> See the overview of fault codes: Fault lists are only available, and can only be deleted, if faults have occurred. <sup>2)</sup> This parameter does not appear if a system control is connected. <sup>3)</sup> This parameter is only available in the products for Spain						

## D Status codes

Code	Meaning
Status external current anode	Anode not connected, Anode OK, Anode Fault
S.34 Heating mode: Frost protection	If the measured outdoor temperature falls below XX °C, the temperature of the heating circuit's flow and return is monitored. If the temperature difference exceeds the set value, the pump and compressor are started without a heat demand.
S.100 Standby	There is no heat demand or cooling demand. Standby 0: Outdoor unit. Standby 1: Indoor unit
S.101 Heating: Compressor shutdown	The heat demand is met, the demand is ended by the system control and the heat deficit is offset. The compressor is switched off.
S.102 Heating: Compressor blocked	The compressor is blocked for heating mode because the heat pump is outside of its application limits.
S.103 Heating: Prerun	The start conditions for the compressor in heating mode are checked. Start the other actuators for heating mode.
S.104 Heating: Compressor active	The compressor works in order to meet the heat demand.
S.107 Heating: Overrun	The heat demand is met, the compressor is switched off. The pump and fan overrun.
S.111 Cooling: Compressor shutdown	The cooling demand is met, the demand is ended by the system control. The compressor is switched off.
S.112 Cooling: Compressor blocked	The compressor is blocked for cooling mode because the heat pump is outside of its application limits.
S.113 Cooling: Compressor mode prerun	The start conditions for the compressor in cooling mode are checked. Start the other actuators for cooling mode.
S.114 Cooling: Compressor active	The compressor works in order to meet the cooling demand.
S.117 Cooling: Compressor mode overrun	The cooling demand is met, the compressor is switched off. The pump and fan overrun.
S.125 Heating: Immersion heater active	The external back-up heater is used in heating mode.
S.132 Domestic hot water: Compressor blocked	The compressor is blocked for domestic hot water mode because the heat pump is outside of the application limits.
S.133 Domestic hot water: Prerun	The start conditions for the compressor in domestic hot water mode are checked. Start the other actuators for domestic hot water mode.
S.134 Domestic hot water: Compressor active	The compressor works in order to meet the domestic hot water demand.

Code	Meaning
<b>S.135 Domestic hot water: Immersion heater active</b>	The external back-up heater is used in domestic hot water mode.
<b>S.137 Domestic hot water: Overrun</b>	The domestic hot water demand is met, the compressor is switched off. The pump and fan overrun.
<b>S.141 Heating: Immersion heater shutdown</b>	The heat demand is met, the external back-up heater is switched off.
<b>S.142 Heating: Immersion heater blocked</b>	The external back-up heater is blocked for heating mode.
<b>S.151 Domestic hot water: Immersion heater shutdown</b>	The domestic hot water demand is met, the external back-up heater is switched off.
<b>S.152 Domestic hot water: Immersion heater blocked</b>	The external back-up heater is blocked for domestic hot water mode.
<b>S.173 Anti-cycling time for the energy supply company</b>	The mains voltage supply is interrupted by the energy supply company. The maximum anti-cycling time is set in the configuration.
<b>S.202 Check programme: Purging of building circuit active</b>	The building circuit pump is actuated in cyclical intervals, alternately in heating mode and domestic hot water mode.
<b>S.203 Actuator test active</b>	The sensor and actuator test is currently operating.
<b>S.212 Connection fault: Control not recognised</b>	System control was previously detected but the connection is broken. Check the eBUS connection to the system control. It can only be operated with the heat pump's additional functions.
<b>S.240 Compr. oil temp. too low, environment too cold</b>	The compressor heating is switched on. The unit does not start up.
<b>S.252 Fan unit 1: Fan blocked</b>	If the fan speed is 0 rpm, the heat pump is switched off for 15 minutes and then restarted. If the fan does not start up after four unsuccessful restarts, the heat pump is switched off and the fault message <b>F.718</b> is displayed.
<b>S.255 Fan unit 1: Air inlet temp. too high</b>	The compressor does not start because the outdoor temperature at the fan is above the application limits. Heating mode: > 43 °C. Domestic hot water mode: > 43 °C. Cooling mode: > 46 °C.
<b>S.256 Fan unit 1: Air inlet temp. too low</b>	The compressor does not start because the outdoor temperature at the fan is below the application limits. Heating mode: < -20 °C. Domestic hot water mode: < -20 °C. Cooling mode: < 15 °C.
<b>S.260 Fan unit 2: Fan blocked</b>	If the fan speed is 0 rpm, the heat pump is switched off for 15 minutes and then restarted. If the fan does not start up after four unsuccessful restarts, the heat pump is switched off and the fault message <b>F.785</b> is displayed.
<b>S.272 Building circuit: Remaining feed head limit active</b>	The remaining feed head that is set under the configuration is reached.
<b>S.273 Building circuit: Flow temperature too low</b>	The flow temperature that is measured in the building circuit is below the application limits.
<b>S.275 Building circuit: Flow rate too low</b>	Building circuit pump defective. All consumers in the heating system are closed. The values fall below the specific minimum volume flows. Check that the dirt filter is permeable. Check the stopcocks and thermostatic valves. Ensure that the flow rate is at least 35% of the nominal flow rate. Check that the building circuit pump functions correctly.
<b>S.276 Building circuit: Lock-out contact S20 open</b>	Contact S20 is open at the heat pump's main PCB. Incorrect limit thermostat setting. Flow temperature sensor (heat pump, gas-fired boiler, system sensor) measures values that deviate downwards. Adjust the maximum flow temperature for the direct heating circuit via the system control (observe the upper switch-off threshold for the boilers). Adjust the set value for the limit thermostat. Check the sensor values
<b>S.277 Building circuit: Pump fault</b>	If the building circuit pump is inactive, the heat pump is switched off for 10 minutes and is then restarted. If the building circuit pump does not start up after three unsuccessful restarts, the heat pump is switched off and the fault message <b>F.788</b> is displayed.
<b>S.280 Freq. converter fault: Compressor</b>	The compressor motor or wiring is defective.
<b>S.281 Freq. converter fault: Mains voltage</b>	There is overvoltage or undervoltage.
<b>S.282 Freq. converter fault: Overheating</b>	If the cooling of the frequency inverter is not sufficient, the heat pump is switched off for one hour and then restarted again. If the cooling is not sufficient after three unsuccessful restarts, the heat pump is switched off and the fault message <b>F.819</b> is displayed.
<b>S.283 De-icing time too long</b>	If the de-icing takes longer than 15 minutes, the heat pump is restarted. If the time for the de-icing is still not sufficient after three unsuccessful restarts, the heat pump is switched off and the fault message <b>F.741</b> is displayed. ► Check whether sufficient heat energy is available from the building circuit.
<b>S.284 De-icing flow temperature too low</b>	If the flow temperature is below 5 °C, the heat pump is restarted. If the flow temperature is still not sufficient after three unsuccessful restarts, the heat pump is switched off and the fault message <b>F.741</b> is displayed. ► Check whether sufficient heat energy is available from the building circuit.
<b>S.285 Compressor outlet temperature too low</b>	Compressor outlet temperature is too low
<b>S.286 Hot gas temperature switch open</b>	If the hot gas temperature is above 119 °C +5 K, the heat pump is switched off for one hour and then restarted again. If the hot gas temperature has not fallen after three unsuccessful restarts, the heat pump is switched off and the fault message <b>F.823</b> is displayed.



Code	Meaning
<b>S.287 Fan 1: Wind</b>	Before starting, the fan rotates at a speed of 50 rpm or higher. This may be caused by a strong outside wind.
<b>S.288 Fan 2: Wind</b>	Before starting, the fan rotates at a speed of 50 rpm or higher. This may be caused by a strong outside wind.
<b>S.289 Current limit active</b>	The outdoor unit's power consumption is reduced, the compressor speed is reduced. The compressor's operating current exceeds the limit value that is set under the configuration. (for 3 kW, 5 kW, 7 kW units: <16 A; for 10 kW, 12 kW units: <25 A)
<b>S.290 Switch-on delay active</b>	The compressor's switch-on delay is active.
<b>S.302 High-pressure switch open</b>	If the pressure in the refrigerant circuit exceeds the application limit, the heat pump is switched off for 15 minutes and is then restarted again. If the pressure remains too high after four unsuccessful restarts, the fault message <b>F.731</b> is displayed.
<b>S.303 Compressor outlet temperature too high</b>	The operating characteristics have been exited. The heat pump is restarted.
<b>S.304 Evaporation temperature too low</b>	The operating characteristics have been exited. The heat pump is restarted.
<b>S.305 Condensation temperature too low</b>	The operating characteristics have been exited. The heat pump is restarted.
<b>S.306 Evaporation temperature too high</b>	The operating characteristics have been exited. The heat pump is restarted.
<b>S.308 Condensation temperature too high</b>	The operating characteristics have been exited. The heat pump is restarted.
<b>S.312 Building circuit: Return temperature too low</b>	Return temperature in the building circuit too low for compressor to start. Heating: Return temperature < 5 °C. Cooling: Return temperature < 10 °C. Cooling: Check that the 4-port diverter valve works correctly.
<b>S.314 Building circuit: Return temperature too high</b>	Return temperature in the building circuit too high for the compressor to start. Heating: Return temperature > 56 °C. Cooling: Return temperature > 35 °C. Cooling: Check that the 4-port diverter valve works correctly. Check the sensors.
<b>S.516 De-icing mode active</b>	The heat pump de-ices the outdoor unit's heat exchanger. The heating mode is interrupted. The maximum de-icing time is 16 minutes.
<b>S.575 Frequency converter: Internal fault</b>	An internal electronics fault is present on the outdoor unit's inverter PCB. If this occurs three times, fault message F.752 appears.
<b>S.581 Connection fault: Frequency converter not recognised</b>	Missing communication between the frequency converter and the outdoor unit's PCB. After this occurs three times, fault message F.753 appears.
<b>S.590 Fault: 4-port valve position not correct</b>	The 4-port diverter valve does not move fully to the heating or cooling position.

## E Maintenance messages

Code	Meaning	Cause	Remedy
<b>M.32</b>	<b>Building circuit: Waterpress. Low</b>	<ul style="list-style-type: none"> <li>– Pressure loss in the building circuit due to leakages or air pockets</li> <li>– Building circuit pressure sensor is defective</li> </ul>	<ul style="list-style-type: none"> <li>– Check the building circuit for leaks, top up with heating water and purge</li> <li>– Check the plug contact on the PCB and on the wiring harness; check that the pressure sensor is working correctly and, if required, replace the pressure sensor</li> </ul>
<b>M.201</b>	<b>Sensor fault: Cylinder temperature</b>	<ul style="list-style-type: none"> <li>– Cylinder temperature sensor defective</li> </ul>	<ul style="list-style-type: none"> <li>– Check the plug contact on the PCB and on the wiring harness; check that the sensor is working correctly and, if required, replace the sensor</li> </ul>
<b>M.202</b>	<b>Sensor fault: System temperature</b>	<ul style="list-style-type: none"> <li>– System temperature sensor defective</li> </ul>	<ul style="list-style-type: none"> <li>– Check the plug contact on the PCB and on the wiring harness; check that the sensor is working correctly and, if required, replace the sensor</li> </ul>
<b>M.203</b>	<b>Connection fault: Disp. not recognised</b>	<ul style="list-style-type: none"> <li>– Display defective</li> <li>– Display not connected</li> </ul>	<ul style="list-style-type: none"> <li>– Check the quality of the plug contact on the PCB and on the wiring harness</li> <li>– Replace the display, if required</li> </ul>

## F Fault codes

Code	Meaning	Cause	Remedy
F.022	<b>Building circuit: Water press. too low</b>	<ul style="list-style-type: none"> <li>- Pressure loss in the building circuit due to leakages or air pockets</li> <li>- Building circuit pressure sensor defective</li> </ul>	<ul style="list-style-type: none"> <li>- Check the building circuit for leaks</li> <li>- Top up with water, purge</li> <li>- Check the quality of the plug contact on the PCB and on the wiring harness</li> <li>- Check that the pressure sensor is working correctly</li> <li>- Replace the pressure sensor</li> </ul>
F.042	<b>Fault: Coding resistor</b>	<ul style="list-style-type: none"> <li>- Coding resistor damaged or not set</li> </ul>	<ul style="list-style-type: none"> <li>- Check that the coding resistor is positioned correctly and, if required, replace it.</li> </ul>
F.073	<b>Sensor fault: Building circ. water pressure</b>	<ul style="list-style-type: none"> <li>- The sensor is not connected or the sensor input has short-circuited</li> </ul>	<ul style="list-style-type: none"> <li>- Check and, if required, replace the sensor</li> <li>- Replace the wiring harness</li> </ul>
F.094	<b>Fault: Vortex</b>	<ul style="list-style-type: none"> <li>- Volume flow sensor not connected or sensor input has short-circuited</li> </ul>	<ul style="list-style-type: none"> <li>- Check and, if required, replace the sensor</li> <li>- Replace the wiring harness</li> </ul>
F.103	<b>Fault: Spare part ident.</b>	<ul style="list-style-type: none"> <li>- Incorrect control PCB installed on the outdoor unit</li> </ul>	<ul style="list-style-type: none"> <li>- Installing the correct PCB</li> </ul>
F.514	<b>Sensor fault: Compr. inlet temp.</b>	<ul style="list-style-type: none"> <li>- The sensor is not connected or the sensor input has short-circuited</li> </ul>	<ul style="list-style-type: none"> <li>- Check and, if required, replace the sensor</li> <li>- Replace the wiring harness</li> </ul>
F.517	<b>Sensor fault: Compr. outlet temp.</b>	<ul style="list-style-type: none"> <li>- The sensor is not connected or the sensor input has short-circuited</li> </ul>	<ul style="list-style-type: none"> <li>- Check and, if required, replace the sensor</li> <li>- Replace the wiring harness</li> </ul>
F.519	<b>Sensor fault: Building circuit return temp.</b>	<ul style="list-style-type: none"> <li>- The sensor is not connected or the sensor input has short-circuited</li> </ul>	<ul style="list-style-type: none"> <li>- Check and, if required, replace the sensor</li> <li>- Replace the wiring harness</li> </ul>
F.520	<b>Sensor fault: Building circuit flow temp.</b>	<ul style="list-style-type: none"> <li>- The sensor is not connected or the sensor input has short-circuited</li> </ul>	<ul style="list-style-type: none"> <li>- Check and, if required, replace the sensor</li> <li>- Replace the wiring harness</li> </ul>
F.526	<b>Sensor fault: EEV outlet temp.</b>	<ul style="list-style-type: none"> <li>- The sensor is not connected or the sensor input has short-circuited</li> </ul>	<ul style="list-style-type: none"> <li>- Check and, if required, replace the sensor</li> <li>- Replace the wiring harness</li> </ul>
F.546	<b>Sensor fault: High pressure</b>	<ul style="list-style-type: none"> <li>- The sensor is not connected or the sensor input has short-circuited</li> </ul>	<ul style="list-style-type: none"> <li>- Check the sensor (e.g. using an installation aid), and replace if necessary</li> <li>- Replace the wiring harness</li> </ul>
F.582	<b>Fault: EEV</b>	<ul style="list-style-type: none"> <li>- EEV is not connected correctly or there is a cable break to the coil</li> </ul>	<ul style="list-style-type: none"> <li>- Check the plug connections and, if required, replace the coil from the EEV</li> </ul>
F.585	<b>Sensor fault: Capac. outlet temp.</b>	<ul style="list-style-type: none"> <li>- The sensor is not connected or the sensor input has short-circuited</li> </ul>	<ul style="list-style-type: none"> <li>- Check and, if required, replace the sensor</li> <li>- Replace the wiring harness</li> </ul>
F.703	<b>Sensor fault: Low pressure</b>	<ul style="list-style-type: none"> <li>- The sensor is not connected or the sensor input has short-circuited</li> </ul>	<ul style="list-style-type: none"> <li>- Checking the sensor (e.g. using an installation aid), and replacing it if necessary</li> <li>- Replace the wiring harness</li> </ul>
F.718	<b>Fan unit 1: Fan blocked</b>	<ul style="list-style-type: none"> <li>- There is no confirmation signal stating that the fan is rotating</li> </ul>	<ul style="list-style-type: none"> <li>- Check the air route and, if required, remove any blockages</li> </ul>
F.729	<b>Compressor outlet temperature too low</b>	<ul style="list-style-type: none"> <li>- The compressor outlet temperature is lower than 0 °C for more than 10 minutes or the compressor outlet temperature is lower than -10 °C even though the heat pump is in the operating characteristics.</li> </ul>	<ul style="list-style-type: none"> <li>- Checking the high-pressure sensor</li> <li>- Checking that the EEV is working correctly</li> <li>- Check the condenser outlet temperature sensor (subcooling)</li> <li>- Check whether the 4-port diverter valve is in the intermediate position</li> <li>- Checking the refrigerant volume for overfilling</li> </ul>

Code	Meaning	Cause	Remedy
F.731	<b>High-pressure switch open</b>	<ul style="list-style-type: none"> <li>- Refrigerant pressure too high. The integrated high-pressure switch in the outdoor unit has tripped at 41.5 bar (g) or 42.5 bar (abs)</li> <li>- Insufficient energy output via the condenser</li> </ul>	<ul style="list-style-type: none"> <li>- Purging the building circuit</li> <li>- Too low a volume flow as a result of closing single room controls in an underfloor heating system</li> <li>- Check that the dirt filter that is in place is permeable</li> <li>- Refrigerant flow rate too low (e.g. electronic expansion valve defective, 4-port diverter valve is mechanically blocked, filter is blocked). Inform customer service.</li> <li>- Cooling mode: Check the fan unit for dirt</li> <li>- Check the high-pressure switch and high-pressure sensor</li> <li>- Reset the high-pressure switch and carry out a manual reset on the product.</li> </ul>
F.732	<b>Compressor outlet temperature too high</b>	<p>The compressor outlet temperature is above 110 °C:</p> <ul style="list-style-type: none"> <li>- Application limits exceeded</li> <li>- EEV does not work or does not open correctly</li> <li>- Refrigerant volume too low (frequent defrosting due to extremely low evaporation temperatures)</li> </ul>	<ul style="list-style-type: none"> <li>- Check the compressor inlet sensor and outlet sensor</li> <li>- Check the compressor outlet temperature sensor (TT135)</li> <li>- Check the EEV (does the EEV move to the limit stop? Use the sensor/actuator test)</li> <li>- Check the refrigerant volume (see Technical data)</li> <li>- Carry out a leak-tightness test</li> <li>- Check whether the service valves on the outdoor unit are open.</li> </ul>
F.733	<b>Evaporation temperature too low</b>	<ul style="list-style-type: none"> <li>- Insufficient air volume flow through the outdoor unit's heat exchanger (heating mode) leads to an insufficient energy input in the environment circuit (heating mode) or building circuit (cooling mode)</li> <li>- Refrigerant volume too low</li> </ul>	<ul style="list-style-type: none"> <li>- If the building circuit contains thermostatic valves, check that they are suitable for cooling mode (check volume flow in cooling mode)</li> <li>- Check the fan unit for dirt</li> <li>- Check the EEV (does the EEV move to the limit stop? Use the sensor/actuator test)</li> <li>- Check the compressor inlet sensor</li> <li>- Check the refrigerant volume</li> </ul>
F.734	<b>Condensation temperature too low</b>	<ul style="list-style-type: none"> <li>- The temperature in the heating circuit is too low, outside of the operating characteristics</li> <li>- Refrigerant volume too low</li> </ul>	<ul style="list-style-type: none"> <li>- Check the EEV (does the EEV move to the limit stop? Use the sensor/actuator test)</li> <li>- Check the compressor inlet sensor</li> <li>- Check the refrigerant filling volume (see technical data)</li> <li>- Check whether the 4-port diverter valve is in an intermediate position and is not correctly switched</li> <li>- Check the high-pressure sensor</li> <li>- Check the pressure sensor in the heating circuit</li> </ul>
F.735	<b>Evaporation temperature too high</b>	<ul style="list-style-type: none"> <li>- Temperature in the environment circuit (heating mode) or building circuit (cooling mode) too high for compressor operation</li> <li>- Feed-in of external heat into the environment circuit too high due to increased fan speed</li> </ul>	<ul style="list-style-type: none"> <li>- Check the system temperatures</li> <li>- Check the refrigerant filling volume for overfilling</li> <li>- Check the EEV (does the EEV move to the limit stop? Use sensor/actuator test)</li> <li>- Check the sensor for the evaporation temperature (depending on the position of the 4-port diverter valve)</li> <li>- Check the volume flow in cooling mode</li> <li>- Check the air volume flow in heating mode</li> </ul>

Code	Meaning	Cause	Remedy
F.737	<b>Condensation temperature too high</b>	<ul style="list-style-type: none"> <li>- Temperature in the environment circuit (cooling mode) or building circuit (heating mode) too high for compressor operation</li> <li>- Feed-in of external heat into the building circuit</li> <li>- Refrigerant circuit overfilled</li> <li>- Insufficient flow rate in the building circuit</li> </ul>	<ul style="list-style-type: none"> <li>- Reduce or stop the external heat that is entering</li> <li>- Check the back-up heater (heats up even though it is off in the sensor/actuator test?)</li> <li>- Check the EEV (does the EEV move to the limit stop? Use the sensor/actuator test)</li> <li>- Check the compressor outlet sensor, compressor outlet temperature sensor (TT135) and high-pressure sensor</li> <li>- Check the refrigerant filling volume for overfilling</li> <li>- Check whether the service valves on the outdoor unit are open.</li> <li>- Check the air volume flow in cooling mode for sufficient flow rate</li> <li>- Checking the heating pump</li> <li>- Check the building circuit flow rate</li> </ul>
F.741	<b>Building circuit: Return temp. too low</b>	<ul style="list-style-type: none"> <li>- During the de-icing, the return temperature falls below 13 °C</li> </ul>	<ul style="list-style-type: none"> <li>- Ensure the minimum installation volume is maintained; if required, install a series return cylinder</li> <li>- The fault message is displayed until the return temperature increases to above 20 °C.</li> <li>- Activate the electric back-up heater in the product's control panel and in the system control in order to increase the return temperature. The compressor is blocked while the fault message is present.</li> </ul>
F.752	<b>Fault: Frequency converter</b>	<ul style="list-style-type: none"> <li>- Internal electronics fault on the inverter PCB</li> <li>- Mains voltage outside of 70 V–282 V</li> </ul>	<ul style="list-style-type: none"> <li>- Check the integrity of the power supply cables and compressor connection cables The plugs must audibly click into place.</li> <li>- Check the cable</li> <li>- Check the mains voltage The mains voltage must be between 195 V and 253 V.</li> <li>- Check the phases</li> <li>- Replace the frequency converter, if required</li> </ul>
F.753	<b>Connection fault: Freq. conversion recogn.</b>	<ul style="list-style-type: none"> <li>- Missing communication between the frequency converter and the outdoor unit's control PCB</li> </ul>	<ul style="list-style-type: none"> <li>- Check the integrity of the wiring harness and plug connection and, if required, replace them</li> <li>- Check the frequency converter by actuating the compressor safety relay</li> <li>- Read the assigned parameters for the frequency converter and check whether values are displayed</li> </ul>
F.755	<b>Fault: 4-port valve position not correct</b>	<ul style="list-style-type: none"> <li>- Incorrect position of the 4-port diverter valve. If, in heating mode, the flow temperature is lower than the return temperature in the building circuit.</li> <li>- The temperature sensor in the electronic expansion valve environment circuit displays an incorrect temperature.</li> </ul>	<ul style="list-style-type: none"> <li>- Check the 4-port diverter valve (is an audible switching available? Use the sensor/actuator test)</li> <li>- Check that the coil is positioned correctly on the 4-port valve</li> <li>- Check the wiring harness and plug connections</li> <li>- Check the temperature sensor in the electronic expansion valve environment circuit</li> </ul>
F.774	<b>Sensor fault: Air inlet temp.</b>	<ul style="list-style-type: none"> <li>- The sensor is not connected or the sensor input has short-circuited</li> </ul>	<ul style="list-style-type: none"> <li>- Check and, if required, replace the sensor</li> <li>- Replace the wiring harness</li> </ul>
F.785	<b>Fan unit 2: Fan blocked</b>	<ul style="list-style-type: none"> <li>- There is no confirmation signal stating that the fan is rotating</li> </ul>	<ul style="list-style-type: none"> <li>- Check the air route and, if required, remove any blockages</li> </ul>

Code	Meaning	Cause	Remedy
F.788	<b>Building circuit: Pump fault</b>	<ul style="list-style-type: none"> <li>– The electronics system of the high-efficiency pump has detected a fault (e.g. dry running, blockage, overvoltage, undervoltage) and has switched off and locked the pump.</li> </ul>	<ul style="list-style-type: none"> <li>– Switch the heat pump off for at least 30 seconds (no current)</li> <li>– Check the quality of the plug contact on the PCB</li> <li>– Check that the pump functions correctly</li> <li>– Purging the building circuit</li> <li>– Check that the dirt filter that is in place is permeable</li> </ul>
F.817	<b>Freq. converter fault: Compressor</b>	<ul style="list-style-type: none"> <li>– Defect in the compressor (e.g. short circuit)</li> <li>– Defect in the frequency converter</li> <li>– Connection cable to the compressor is defective or loose</li> </ul>	<ul style="list-style-type: none"> <li>– Measure the winding resistance in the compressor</li> <li>– Measure the frequency converter output between the three phases, (it must be &gt; 1 kΩ)</li> <li>– Check the wiring harness and plug connections</li> </ul>
F.818	<b>Freq. converter fault: Mains voltage</b>	<ul style="list-style-type: none"> <li>– Incorrect mains voltage for operating the frequency converter</li> <li>– Shutdown via the energy supply company</li> </ul>	<ul style="list-style-type: none"> <li>– Measure and, if required, correct the mains voltage</li> </ul> <p>The mains voltage must be between 195 V and 253 V.</p>
F.819	<b>Freq. converter fault: Overheating</b>	<ul style="list-style-type: none"> <li>– Internal overheating of the frequency converter</li> </ul>	<ul style="list-style-type: none"> <li>– Allow the frequency converter to cool and restart the product</li> <li>– Check the frequency converter's air route</li> <li>– Check that the fan is working correctly</li> <li>– The maximum environmental temperature of the outdoor unit (46 °C) has been exceeded.</li> </ul>
F.820	<b>Connection fault: Building circuit pump</b>	<ul style="list-style-type: none"> <li>– Pump does not report any signal back to the heat pump</li> </ul>	<ul style="list-style-type: none"> <li>– Check the cable to the pump for defects and, if required, replace it</li> <li>– Replace the pump</li> </ul>
F.823	<b>Hot gas temperature switch open</b>	<ul style="list-style-type: none"> <li>– The hot gas thermostat shuts down the heat pump if the temperature in the refrigerant circuit is too high. Following a waiting period, the heat pump attempts to start once more. After three failed start attempts in succession, a fault message is displayed.</li> <li>– Max. refrigerant circuit temperature: 110 °C</li> <li>– Waiting period: 5 mins (after it first occurs)</li> <li>– Waiting period: 30 mins (after it occurs a second time and any other time after that)</li> <li>– The fault counter is reset if both of the following conditions are met: <ul style="list-style-type: none"> <li>– Heat requirement without switching off prematurely</li> <li>– 60 mins uninterrupted operation</li> </ul> </li> </ul>	<ul style="list-style-type: none"> <li>– Check the EEV</li> <li>– Replace the dirt filter in the refrigeration circuit, if required</li> </ul>
F.825	<b>Sensor fault: Capac. inlet temp.</b>	<ul style="list-style-type: none"> <li>– Refrigerant circuit temperature sensor (vapour-forming) not connected or the sensor input has short-circuited</li> </ul>	<ul style="list-style-type: none"> <li>– Check and, if required, replace the sensor and cable</li> </ul>
F.1117	<b>Compressor: Phase failure</b>	<ul style="list-style-type: none"> <li>– Defective fuse</li> <li>– Incorrect electrical connections</li> <li>– Mains voltage too low</li> <li>– Compressor/low tariff power supply not connected</li> <li>– Energy supply company lockout for longer than three hours</li> </ul>	<ul style="list-style-type: none"> <li>– Check the fuse</li> <li>– Checking the electrical connections</li> <li>– Check the voltage at the heat pump electrical connection</li> <li>– Reduce energy supply company anti-cycling time to under three hours</li> </ul>
F.9998	<b>Connection fault: Heat pump</b>	<ul style="list-style-type: none"> <li>– eBUS cable not connected or connected incorrectly</li> <li>– Outdoor unit without supply voltage</li> </ul>	<ul style="list-style-type: none"> <li>– Check the connection pipes between the power supply PCB and control PCB on the indoor and outdoor unit</li> </ul>

## G Characteristic values for the internal temperature sensors, hydraulic circuit

Sensors: TT620 TT650

Temperature (°C)	Resistance (ohms)
0	33400
5	25902
10	20247
15	15950
20	12657
25	10115
30	8138
35	6589
40	5367
45	4398
50	3624
55	3002
60	2500
65	2092
70	1759
75	1486
80	1260
85	1074
90	918
95	788
100	680
105	588
110	510

## H Characteristic values for the VRC DCF outdoor temperature sensor

Temperature (°C)	Resistance (ohms)
-25	2167
-20	2067
-15	1976
-10	1862
-5	1745
0	1619
5	1494
10	1387
15	1246
20	1128
25	1020
30	920
35	831
40	740

## I Technical data

	VWZ AI VWL X/2 A
Operating voltage $U_{\max}$	230 V
Power consumption	$\leq 2 \text{ V}\cdot\text{A}$
Contact loading of the output relay	$\leq 2 \text{ A}$
Total current	$\leq 4 \text{ A}$
Sensor operating voltage	3.3 V
Cross-section of eBUS line (extra low voltage)	$\geq 0.75 \text{ mm}^2$
Cross-section of sensor line (extra low voltage)	$\geq 0.75 \text{ mm}^2$
Cross-section of 230 V connection cable (pump or mixer connection cable)	$\geq 1.5 \text{ mm}^2$
IP rating	IP 20
Protection class	II
Maximum environmental temperature	40 °C
Height	174 mm
Width	272 mm
Depth	52 mm

## Index

<b>A</b>		
Actuator test .....	24	
Actuators, checking .....	24	
<b>C</b>		
Calling up, code layer .....	22	
Calling up, installer level .....	22	
Calling up, statistics .....	22	
CE marking .....	18	
Check programmes .....	24	
Checking, maintenance message .....	24	
Checking, service message .....	24	
Circulation pump, connecting .....	21	
Code layer, calling up .....	22	
Comfort protection mode .....	24	
Competent person .....	15	
Component test .....	24	
<b>D</b>		
Decommissioning .....	24	
Deleting personal data .....	24	
Displaying, Live Monitor .....	24	
Displaying, status codes .....	24	
Disposing of batteries .....	24	
Disposing of the product .....	24	
Documents .....	17	
<b>E</b>		
Electricity .....	15	
Energy supply company lockout .....	20	
<b>F</b>		
Factory settings, restoring .....	24	
Fault codes .....	23	
Fault memory .....	24	
Fault symbol .....	24	
Filling pressure, displaying .....	22	
Frost protection function .....	18	
Function menu .....	24	
<b>I</b>		
Installation assistant .....	21	
Installer level, calling up .....	22	
Intended use .....	15	
<b>L</b>		
Live Monitor, displaying .....	24	
Low-water pressure protection .....	18	
<b>M</b>		
Maintenance message, checking .....	24	
<b>O</b>		
Operating concept .....	21	
<b>P</b>		
Parameters, resetting .....	24	
Product, switching on .....	21	
<b>Q</b>		
Qualification .....	15	
<b>R</b>		
Recycling/disposing of packaging .....	24	
Regulations .....	16	
<b>S</b>		
Screed drying, function .....	22	
Self-test .....	24	
Sensor test .....	24	
Service message, checking .....	24	
Service partner .....	23	
Statistics, calling up .....	22	
Status codes, displaying .....	24	
Switching on, product .....	21	
<b>T</b>		
Test menu .....	24	
Tool .....	16	
<b>U</b>		
Unit configuration, checking .....	22	
<b>V</b>		
Voltage .....	15	
<b>W</b>		
Wiring .....	20	









**Supplier**

**Vaillant Ltd.**

Nottingham Road ■ Belper ■ Derbyshire ■ DE56 1JT

Telephone 0330 100 3143

info@vaillant.co.uk ■ www.vaillant.co.uk

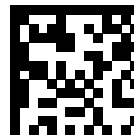

0020291573\_01

**Publisher/manufacturer**

**Vaillant GmbH**

Berghauser Str. 40 ■ D-42859 Remscheid

Tel. +49 2191 18 0 ■ Fax +49 2191 18 2810

info@vaillant.de ■ www.vaillant.de

© These instructions, or parts thereof, are protected by copyright and may be reproduced or distributed only with the manufacturer's written consent.

Subject to technical modifications.