

# sensoCOMFORT

VRC 720/3

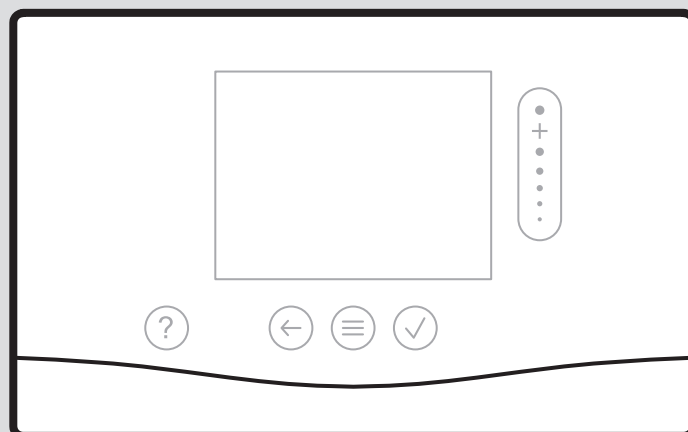



TRANSLATION



en	Operating and installation instructions .....	3
en	Country specifics.....	59

# Operating and installation instructions

## Contents

<b>1</b>	<b>Safety</b> .....	<b>4</b>	<b>6</b>	<b>Fault and maintenance messages</b> .....	<b>51</b>
1.1	Intended use .....	4	6.1	Fault .....	51
1.2	General safety information .....	4	6.2	Fault message .....	52
1.3	 -- Safety/regulations .....	5	6.3	Maintenance message .....	52
<b>2</b>	<b>Product description</b> .....	<b>6</b>	<b>7</b>	<b>Information about the product</b> .....	<b>52</b>
2.1	Which nomenclature is used? .....	6	7.1	Observing and storing other applicable documents .....	52
2.2	What is the effect of the frost protection function? .....	6	7.2	Validity of the instructions .....	52
2.3	What do the following temperatures mean? .....	6	7.3	Data plate .....	52
2.4	What is a zone? .....	6	7.4	Serial number .....	52
2.5	What is the circulation? .....	6	7.5	CE marking .....	52
2.6	What is a fixed value control? .....	6	7.6	Guarantee and customer service .....	52
2.7	Prerequisites for heating mode .....	6	7.7	Recycling and disposal .....	52
2.8	Prerequisites for the cooling mode .....	6	7.8	Product data in accordance with EU Ordinance no. 811/2013, 812/2013 .....	53
2.9	What is meant by "time period"? .....	7	7.9	Technical data – System control .....	53
2.10	What is the effect of the hybrid manager? .....	7	<b>Appendix</b> .....	<b>54</b>	
2.11	Preventing malfunctions .....	7	<b>A</b>	<b>Troubleshooting, maintenance message</b> .....	<b>54</b>
2.12	Setting the heat curve .....	8	A.1	Troubleshooting .....	54
2.13	Display, control elements and symbols .....	8	A.2	Maintenance messages .....	54
2.14	Operating and display functions .....	9	<b>B</b>	 -- <b>Troubleshooting, maintenance message</b> .....	<b>54</b>
<b>3</b>	 -- <b>Electrical installation, set-up</b> .....	<b>23</b>	B.1	Troubleshooting .....	54
3.1	Determining the system control's installation site .....	23	B.2	Troubleshooting .....	55
3.2	Requirements for the eBUS line .....	23	B.3	Maintenance messages .....	57
3.3	Requirements for the sensor cable .....	23	<b>Index</b> .....	<b>58</b>	
3.4	Connecting the system control .....	23			
3.5	Installing the system control and outdoor temperature sensor .....	24			
<b>4</b>	 -- <b>Using the functional modules, basic system diagram, start-up</b> .....	<b>27</b>			
4.1	System without functional modules .....	27			
4.2	System with FM3 functional module .....	27			
4.3	System with FM5 and FM3 functional modules .....	28			
4.4	Potential application for the functional modules .....	28			
4.5	Connection assignment for the FM5 functional module .....	29			
4.6	Connection assignment for the FM3 functional module .....	30			
4.7	Settings for the basic system diagram codes .....	31			
4.8	Combinations of basic system diagram and configuration of functional modules .....	33			
4.9	Basic system diagram and wiring diagram .....	34			
<b>5</b>	 -- <b>Start-up</b> .....	<b>51</b>			
5.1	Prerequisites for starting up .....	51			
5.2	Running the installation assistants .....	51			
5.3	Changing the settings later .....	51			
5.4	Retroactively setting cooling mode .....	51			



## 1 Safety

### 1.1 Intended use

In the event of inappropriate or improper use, damage to the product and other property may arise.

The product is intended for using an eBUS interface to control a heating installation with heat generators from the same manufacturer.

The system control controls based on the installed system:

- Heating
- Cooling
- Ventilation
- Domestic hot water generation
- Circulation

Intended use includes the following:

- observance of accompanying operating, installation and maintenance instructions for the product and any other system components
- installing and setting up the product in accordance with the product and system approval
- compliance with all inspection and maintenance conditions listed in the instructions.

Intended use also covers installation in accordance with the IP code.

This product can be used by children aged from 8 years and above and persons with reduced physical, sensory or mental capabilities or lack of experience and knowledge if they have been given supervision or instruction concerning use of the product in a safe way and understand the hazards involved. Children must not play with the product. Cleaning and user maintenance work must not be carried out by children unless they are supervised.

Any other use that is not specified in these instructions, or use beyond that specified in this document, shall be considered improper use. Any direct commercial or industrial use is also deemed to be improper.

#### **Caution.**

Improper use of any kind is prohibited.

## 1.2 General safety information

### 1.2.1 Danger!

**Validity:** Except Ukraine

- ▶ Risk of burns!
- ▶ Risk of electric shock!
- ▶ For units that are connected to the grid.
- ▶ Before installing the unit, carefully read through the installation instructions.
- ▶ Before starting up the unit, carefully read through the operating instructions.
- ▶ Observe the maintenance regulations in the operating instructions.

### 1.2.2 Qualification

The following work must only be carried out by competent persons who are sufficiently qualified to do so:

- Set-up
- Dismantling
- Installation
- Start-up
- Decommissioning

Work and functions that must only be carried out or set by the competent person are marked by the  symbol.

- ▶ Proceed in accordance with current technology.

### 1.2.3 Danger caused by improper operation

Improper operation may present a danger to you and others, and cause material damage.

- ▶ Carefully read the enclosed instructions and all other applicable documents, particularly the "Safety" section and the warnings.
- ▶ As the end user, you should only carry out those activities for which these instructions provide instructions and that are not marked with the  symbol.





### 1.3 -- Safety/regulations

#### 1.3.1 Risk of material damage caused by frost

- ▶ Do not install the product in rooms prone to frost.

#### 1.3.2 Regulations (directives, laws, standards)

- ▶ Observe the national regulations, standards, directives, ordinances and laws.



## 2 Product description

### 2.1 Which nomenclature is used?

- System control: Instead of VRC 720
- Remote control: Instead of VR 92
- FM3 or FM3 functional module: Instead of VR 70
- FM5 or FM5 functional module: Instead of VR 71

### 2.2 What is the effect of the frost protection function?

The frost protection function protects the heating installation and flat from frost damage.

At outdoor temperatures

- Below 4 °C for longer than four hours, the system control switches the heat generator on and regulates the target room temperature to at least 5 °C.
- Above 4 °C, the system control does not switch the heat generator on, but it monitors the outdoor temperature.

### 2.3 What do the following temperatures mean?

**Desired temp.** is the temperature to which you want to heat or cool the living rooms.

**Set-back temp.** is the level below which the temperature in the living rooms does not fall when outside of the time periods.

**Flow temp.** is the temperature at which the heating water leaves the heat generator.

**Domestic hot water temperature** is the temperature to which the domestic hot water cylinder is to be heated.

### 2.4 What is a zone?

A building can be divided into multiple areas, which are known as zones. A different requirement can be placed on the heating installation in each zone.

Examples for dividing into zones:

- Underfloor heating (zone 1) and a radiator system (zone 2) are available in one building.
- A building is made up of several self-contained residential units. Each residential unit has its own zone.

### 2.5 What is the circulation?

An additional water pipe is connected to the domestic hot water pipe and forms a circuit with the domestic hot water cylinder. A circulation pump facilitates the continuous circulation of domestic hot water through the pipework system which means that hot water is immediately available, even at more distant draw-off points.

### 2.6 What is a fixed value control?

The system control regulates the flow temperature to two fixed temperatures, which are independent from the room or outdoor temperature. This control is suitable for a door air curtain or swimming pool heating, for example.

### 2.7 Prerequisites for heating mode

- The outdoor temperature must be lower than the temperature that the competent person has set in the **MENU | SETTINGS | Installer level | Installation configuration | Circuit | OT switch-off threshold: °C** function.
- In the **MENU | CONTROL | Zone | Heating | Mode:** function, you have selected **Manual** or **Time-contr..**
- Domestic hot water mode is not active.
- For the **MENU | SETTINGS | Installer level | Installation configuration | Circuit | Ext. heat demand:** function, the competent person has defined that a signal from an external control can deactivate the operation of a zone. The function has enabled the operation of a zone.

For heat pumps, also note the following:

- In the **MENU | SETTINGS | Installer level | Installation configuration | Installation | ESCO:** function, the competent person has defined that an external signal can deactivate heating mode. The function has enabled heating mode.

For heat pumps that are equipped with the cooling mode function, also note the following:

- The **MENU | CONTROL | Cooling for several days** function must be deactivated.
- The competent person has activated the **MENU | SETTINGS | Installer level | Installation configuration | Installation | Automatic cooling:** function. The function automatically switches between heating and cooling mode. The function has enabled heating mode.
- The competent person has defined the **Ext. cooling mode** in the **MENU | SETTINGS | Installer level | Installation configuration | HP control module configuration | MI:** function. A signal from an external control switches between heating and cooling mode. As long as no signal is present, heating mode is active.

### 2.8 Prerequisites for the cooling mode

- The heat pump is equipped with the cooling mode function.
- The competent person has set up the heat pump via the required functions for cooling mode.  
Retroactively setting cooling mode (→ Section 5.4)
- In the **MENU | CONTROL | Zone | Cooling | Mode:** function, you have selected **Manual** or **Time-contr..**
- Domestic hot water mode is not active.
- For the **MENU | SETTINGS | Installer level | Installation configuration | Circuit | Ext. heat demand:** function, the competent person has defined that a signal from an external control can deactivate the operation of a zone. The function has enabled the operation of a zone.
- In the **MENU | SETTINGS | Installer level | Installation configuration | Installation | ESCO:** function, the competent person has defined that an external signal can deactivate cooling mode. The function has enabled cooling mode.
- One of the following conditions must be met:

- The **MENU | CONTROL | Cooling for several days** function has been activated.
- The competent person has activated the **MENU | SETTINGS | Installer level | Installation configuration | Installation | Automatic cooling:** function. The function automatically switches between heating and cooling mode. The function has enabled cooling mode.
- The competent person has defined the **Ext. cooling mode** in the **MENU | SETTINGS | Installer level | Installation configuration | HP control module configuration | MI:** function. A signal from an external control switches between heating and cooling mode. As long as a signal is present, cooling mode is active.

## 2.9 What is meant by "time period"?

Example of heating mode in the mode: Time-controlled

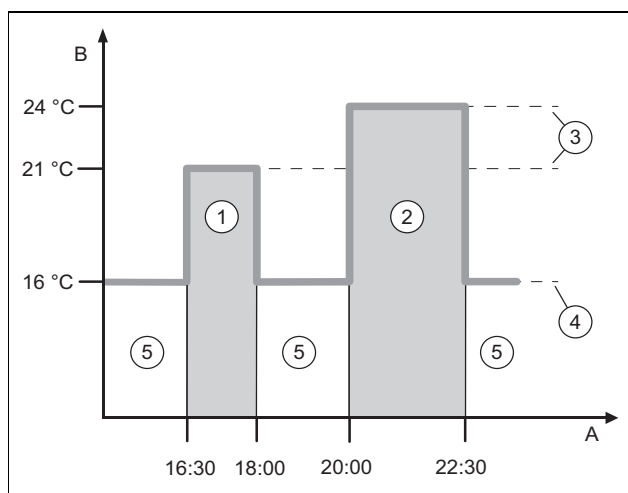

A	Time	3	Desired temperature
B	Temperature	4	Set-back temperature
1	Time period 1	5	Outside of the time periods
2	Time period 2		

You can divide a day up into several time periods **(1)** and **(2)**. Each time period can comprise an individual start time and end time. The time periods must not overlap. You can assign a different desired temperature **(3)** to each time period.

Example:

16:30 to 18:00; 21 °C

20:00 to 22:30; 24 °C

The living rooms are heated to the desired temperature within the time periods. In the times outside of the time periods **(5)**, the living rooms are heated to the lower set-back temperature **(4)** that is set.

Example of cooling mode in the mode: Time-controlled

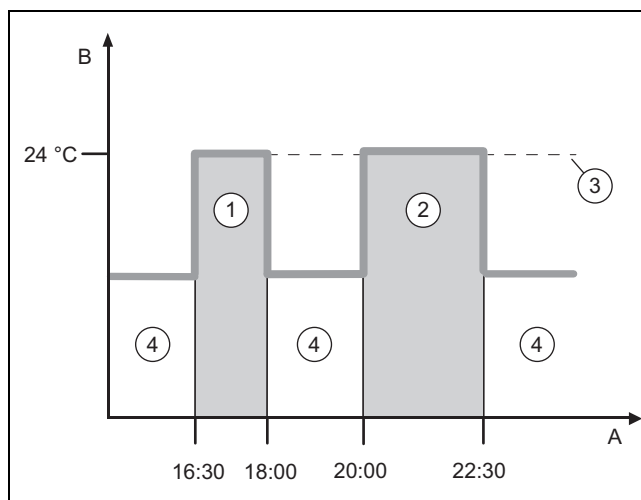

A	Time	2	Time period 2
B	Temperature	3	Desired temperature
1	Time period 1	4	Outside of the time periods

You can divide a day up into several time periods **(1)** and **(2)**. Each time period can comprise an individual start time and end time. The time periods must not overlap. You can set a desired temperature **(3)** that is assigned to all time periods.

Example:

16:30 to 18:00; 24 °C

20:00 to 22:30; 24 °C

The living rooms are cooled to the desired temperature within the time periods. During the times outside of the time periods **(4)**, the living rooms are not cooled.

## 2.10 What is the effect of the hybrid manager?

The hybrid manager calculates whether the heat pump or the additional boiler covers the heat demand cost-effectively. The decision-making criteria are the set tariffs in relation to the heat demand.

To ensure that the heat pump and the additional boiler can work effectively, you must enter the tariffs correctly. See **MENU | SETTINGS**. Otherwise, increases costs may arise.

## 2.11 Preventing malfunctions

- ▶ Do not cover the system control with furniture, curtains or other objects.
- ▶ If the system control is installed in the living room, open all of the thermostatic radiator valves in this room fully.

## 2.12 Setting the heat curve

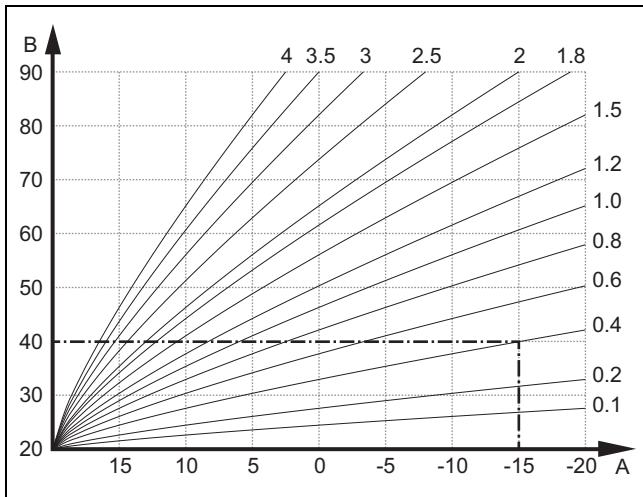

A Outside temperature °C B Target flow temperature °C

The figure shows the possible heat curves of 0.1 to 4.0 for a target room temperature of 20 °C. If, for example, heat curve 0.4 is selected, a flow temperature of 40 °C is maintained at an outdoor temperature of -15 °C.

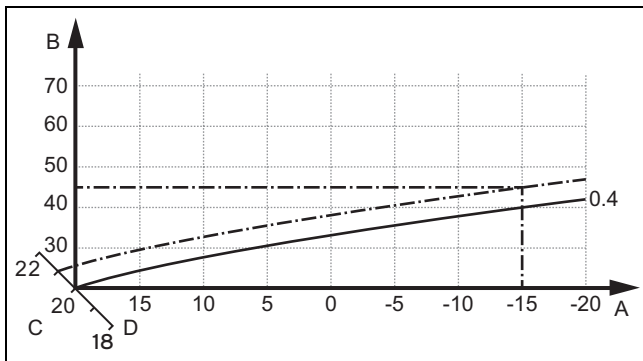

A Outdoor temperature °C B Target flow temperature °C C Target room temperature °C D Axis a

If the heat curve 0.4 is selected and 21 °C is specified for the target room temperature, the heat curve is then translated, as shown in the figure. The heat curve is displaced according to the value of the target room temperature along axis a which is angled at 45°. At an outdoor temperature of -15 °C, the control system provides a flow temperature of 45 °C.

## 2.13 Display, control elements and symbols

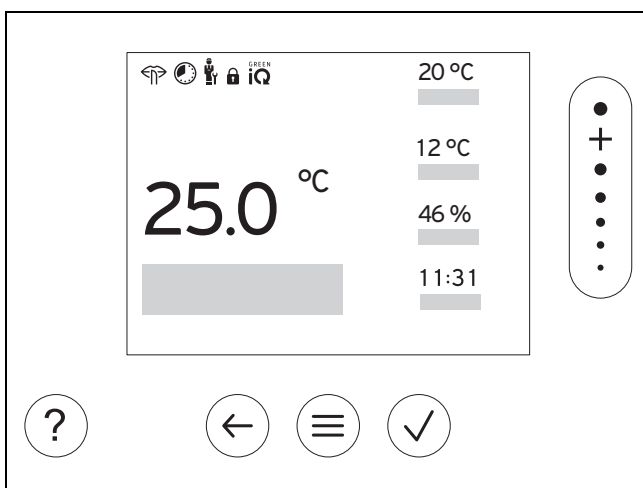

### 2.13.1 Control elements

	- Calling up the menu - Back to the main menu
	- Confirming a selection/change - Saving set values
	- One level back - Cancelling input
	- Navigating through the menu structure - Reducing or increasing the set value - Navigating to individual numbers/letters
	- Calling up help - Calling up the time programme assistant

Active control elements light up.

Press once: You access the basic display.

Press twice: You access the menu.

### 2.13.2 Symbols

	Time-controlled heating active
	Button lock active
	Maintenance required
	Fault in the heating installation
	Contact the competent person
	Noise reduction mode active
	Most energy-efficient heating mode active



## 2.14 Operating and display functions



### Note

The functions described in this section are not available for all system configurations.

To call up the menu, press  twice.

### 2.14.1 Menu item CONTROL

#### MENU

<b>CONTROL</b>		
<b>Zone</b>		
<b>Heating</b>		
<b>Mode:</b>		
<b>Manual</b>		Uninterrupted retention of the desired temperature
<b>Desired temperature: °C</b>		What do the different temperatures mean? (→ Section 2.3)
<b>Time-contr.</b>		What is meant by "time period"? (→ Section 2.9)
<b>Weekly planner</b>		Up to 12 time periods and desired temperatures can be set per day. The competent person sets how the heating installation behaves outside of the time period in the <b>Set-back mode:</b> function. In <b>Set-back mode:</b> means: <ul style="list-style-type: none"> <li>– <b>Eco:</b> The heating is switched off outside of the time periods. Frost protection is activated.</li> <li>– <b>Normal:</b> The set-back temperature applies outside of the time periods.</li> </ul> The <b>Desired temperature: °C</b> applies within the time periods.
<b>Desired temperature: °C</b>		What do the different temperatures mean? (→ Section 2.3)
<b>Set-back temperature: °C</b>		What do the different temperatures mean? (→ Section 2.3)
<b>Off</b>		Heating is switched off, domestic hot water continues to be available, frost protection is activated
<b>Cooling</b>		
<b>Mode:</b>		
<b>Manual</b>		Uninterrupted retention of the desired temperature
<b>Desired temperature: °C</b>		What do the different temperatures mean? (→ Section 2.3)
<b>Time-contr.</b>		What is meant by "time period"? (→ Section 2.9)
<b>Weekly planner</b>		Up to twelve time periods can be set per day The <b>Desired temperature: °C</b> applies within the time periods. Cooling is switched off outside of the time periods.
<b>Desired temperature: °C</b>		What do the different temperatures mean? (→ Section 2.3)
<b>Off</b>		Cooling is switched off, domestic hot water remains available.
<b>Name of zone</b>		Changing the name <b>Zone 1</b> , which was set at the factory
<b>Absence</b>		During this time, heating mode runs at the defined set-back temperature. Domestic hot water mode and circulation are switched off. Frost protection is activated; existing ventilation runs at the lowest level. Factory setting: <b>Set-back temperature: °C 15 °C</b>
<b>All</b>		Applies for all zones within the specified time period.
<b>Zone</b>		Applies for the selected zone in the specified time period.
<b>Cooling for several days</b>		Cooling mode is activated in the specified time period; cooling mode and desired temperature are used from the <b>Cooling</b> function
<b>Fixed value control, circuit 1</b>		
<b>Mode:</b>		
<b>Manual</b>		Uninterrupted retention of the <b>Target flow temp., desired: °C</b> that the competent person set beforehand.
<b>Time-contr.</b>		What is meant by "time period"? (→ Section 2.9)

	<b>Weekly planner</b>	Up to twelve time periods can be set per day Within the time periods, the <b>Target flow temp., desired: °C</b> is used. Outside of the time periods, the <b>Target flow temp., set-back: °C</b> is used or the heating circuit is switched off. At a <b>Target flow temp., set-back: °C = 0 °C</b> , the frost protection can no longer be guaranteed. The competent person sets both of these temperatures beforehand.
	<b>Off</b>	The heating circuit is switched off.
<b>DHW</b>		
	<b>DHW presetting:</b>	Setting the behaviour for domestic hot water mode Factory setting: <b>Comfort</b>
	<b>Comfort</b>	Domestic hot water is generated at the set desired temperature.
	<b>Eco</b>	Domestic hot water is generated for a certain time at a reduced domestic hot water temperature after a significant draw-off (e.g. showering).
	<b>Mode:</b>	
	<b>Manual</b>	Uninterrupted retention of the domestic hot water temperature
	<b>DHW temperature: °C</b>	What do the different temperatures mean? (→ Section 2.3)
	<b>Reduced DHW temperature: °C</b>	Set the domestic hot water temperature to which water should be heated after a significant draw-off (e.g. showering). Factory setting: 49 °C
	<b>Time-contr.</b>	What is meant by "time period"? (→ Section 2.9)
	<b>Domestic hot water weekly planner</b>	Up to three time periods can be set per day Within the time periods, the <b>DHW temperature: °C</b> is used. Domestic hot water mode is switched off outside of the time periods.
	<b>DHW temperature: °C</b>	What do the different temperatures mean? (→ Section 2.3)
	<b>Reduced DHW temperature: °C</b>	Set the domestic hot water temperature to which water should be heated after a significant draw-off (e.g. showering). Factory setting: 49 °C
	<b>Circulation weekly planner</b>	Up to three time periods can be set per day The circulation pump pumps hot water to the draw-off points within the time periods Outside of the time periods, the circulation pump is switched off
	<b>Off</b>	Domestic hot water mode is switched off.
<b>DHW circuit 1</b>		
	<b>Mode:</b>	
	<b>Manual</b>	Uninterrupted retention of the domestic hot water temperature
	<b>DHW temperature: °C</b>	What do the different temperatures mean? (→ Section 2.3)
	<b>Time-contr.</b>	What is meant by "time period"? (→ Section 2.9)
	<b>Domestic hot water weekly planner</b>	Up to three time periods can be set per day Within the time periods, the <b>DHW temperature: °C</b> is used. Domestic hot water mode is switched off outside of the time periods
	<b>DHW temperature: °C</b>	What do the different temperatures mean? (→ Section 2.3)
	<b>Off</b>	Domestic hot water mode is switched off.
<b>Hot water boost</b>		
Heating up the water in the cylinder once		
<b>Ventilation</b>		
	<b>Mode:</b>	
	<b>Normal</b>	Uninterrupted ventilation at ventilation level: <b>Normal</b>
	<b>Normal ventilation level:</b>	Ventilation level for normal operating mode at average room air load with two to four people.
	<b>Time-contr.</b>	
	<b>Weekly planner</b>	Up to twelve time periods can be set per day Within the time periods, the <b>Normal ventilation level:</b> is used. Outside of the time periods, the <b>Reduced ventilation level:</b> is used.

	<b>Normal ventilation level:</b>	Ventilation level for normal operating mode at average room air load with two to four people.
	<b>Reduced ventilation level:</b>	Ventilation level for prolonged absence in order to reduce the energy consumption.
	<b>Reduced</b>	Uninterrupted ventilation at ventilation level: <b>Reduced</b>
	<b>Heat recovery:</b>	
	<b>On</b>	Uninterrupted recovery of the heat from the extract air
	<b>Auto</b>	Internal check of whether the outdoor air is guided via the heat recovery or directly into the living room. See the operating instructions for the ventilation unit.
	<b>Off</b>	Heat recovery is switched off
	<b>Air quality limit: ppm</b>	The ventilation unit keeps the CO <sub>2</sub> content in the room air below the set value.
	<b>Ventilation boost</b>	Heating mode is switched off for 30 minutes and, if available, the ventilation unit runs at the highest ventilation level.
	<b>Humidity prevention</b>	When the <b>Max. room air humidity: %rel</b> is exceeded, the dehumidifier switches on. If the value is not reached, the dehumidifier switches off.
	<b>Max. room air humidity: %rel</b>	Target value for the humidity prevention function
	<b>Time programme assistant</b>	Programming of the desired temperature for Monday–Friday and Saturday–Sunday; the programming applies for the time-controlled <b>Heating Cooling, DHW, Circulation and Ventilation</b> functions Overwrites the weekly planner for the <b>Heating, Cooling, DHW, Circulation and Ventilation</b> functions
	<b>Green iQ:</b>	Switching on the most energy-efficient heating mode, if your installation supports this.
	<b>Installation off</b>	Installation is switched off. Frost protection and, if available, ventilation remain activated at the lowest level.

## 2.14.2 Menu item INFORMATION



### MENU

<b>INFORMATION</b>		
	<b>Ext. power reduction:</b>	Display whether a signal from the energy supply company about the power reduction for your installation is active, inactive or not available.
	<b>Ext. energy manager status:</b>	Active means: The external Energy Manager has taken over the control. The system control displays a reduced selection of functions.
	<b>Current temperatures</b>	
	<b>Zone</b>	Current room temperature in the zone
	<b>DHW temperature</b>	Current temperature in the domestic hot water cylinder
	<b>DHW circuit 1</b>	Current temperature in domestic hot water cylinder circuit 1
	<b>Water pressure: bar</b>	Current water pressure in the heating installation
	<b>Current room air humidity</b>	Current room air humidity, measured using the installed humidity sensor
	<b>Energy data</b>	<p>Display of the energy consumption, energy yields and efficiencies App, boiler and system control display estimated values for energy consumption, energy yields and efficiencies based on an extrapolation. The displayed values in the app may differ based on the different update intervals when compared to the displays in the control panels for the boilers and system control.</p> <p>Among other things, the values depend on:</p> <ul style="list-style-type: none"> <li>– Installation and type of heating installation</li> <li>– User behaviour</li> <li>– Seasonal influences</li> <li>– Tolerances and components</li> </ul> <p>External consumers and generators in the household (e.g. ext. heating pumps or valves) are not taken into consideration. Deviations between the displayed values and the actual values may be considerable; the specifications are therefore not suitable to be used to create or compare energy billing.</p>

<b>Solar yield</b>	Energy yield of the connected solar system
<b>Environmental yield</b>	Energy yield of the heat source installation for the connected heat pumps
<b>Power consumption</b>	The installation's electrical energy consumption based on the respective system function and/or the overall installation
<b>Heating</b>	<b>Current month, Last month, Current year, Last year, Total</b>
<b>DHW</b>	<b>Current month, Last month, Current year, Last year, Total</b>
<b>Cooling</b>	<b>Current month, Last month, Current year, Last year, Total</b>
<b>Installation</b>	<b>Current month, Last month, Current year, Last year, Total</b>
<b>Fuel consumption</b>	The installation's fuel consumption based on the respective system function and/or the overall installation
<b>Heating</b>	<b>Current month, Last month, Current year, Last year, Total</b>
<b>DHW</b>	<b>Current month, Last month, Current year, Last year, Total</b>
<b>Installation</b>	<b>Current month, Last month, Current year, Last year, Total</b>
<b>Heat recovery</b>	Amount of energy saved by the ventilation unit
<b>Burner status:</b>	Current burner status of the connected boiler
<b>Air quality sensor 1:</b>	Measures the CO <sub>2</sub> content of the room air
<b>Control elements</b>	Explanation of the control elements
<b>Menu introduction</b>	Explanation of the menu structure
<b>Competent person contact info</b>	The competent person can store their telephone number.
<b>Phone number</b>	
<b>Company</b>	
<b>Serial number</b>	Identification of the product. The 7th to 16th digits of the serial number form the article number

### 2.14.3 SETTINGS menu item

#### MENU

<b>SETTINGS</b>	
<b>Installer level</b>	
<b>Enter access code</b>	Access to the installer level, factory setting: 00 If the access code is unknown, reset the system control to the factory setting.
<b>End external Energy Manager</b>	After ending, the system control re-assumes its control function with its original settings.
<b>Competent person contact info</b>	Entering contact details
<b>Service date:</b>	Enter the next service date for a connected component, e.g. heat generator, heat pump, ventilation unit
<b>Fault history</b>	Faults are listed in chronological order
<b>Installation configuration</b>	 <b>Installation configuration</b> menu item (→ section 2.14.4)
<b>Sensor/actuator test</b>	Selecting a connected functional module and <ul style="list-style-type: none"> <li>– carrying out a function check of the actuators.</li> <li>– Carry out a plausibility check of the sensors.</li> </ul>
<b>Noise reduction mode</b>	Set the time programme in order to reduce the noise level.
<b>Screed drying</b>	Activate the <b>Screed drying profile</b> function for freshly laid screed in accordance with the construction regulations. The system control regulates the flow temperature independently of the outdoor temperature.  Set screed drying  <b>Installation configuration</b> menu item (→ section 2.14.4)
<b>Change code</b>	Defining an individual access code for the installer level
<b>Language, time, display</b>	
<b>Language:</b>	Defining the language that is to be shown on the display.
<b>Date:</b>	After the power is switched off, the date is retained for approx. 30 minutes.

<b>Time:</b>	After the power is switched off, the time is retained for approx. 30 minutes.
<b>Display brightness:</b>	Brightness during active use.
<b>Dimmed displ. brightness:</b>	Brightness in standby.
<b>Daylight saving time:</b>	Define whether daylight saving time should be used. For outdoor temperature sensors with DCF77 receivers, the <b>Daylight saving time:</b> function is not used. The conversion to summer/winter time takes place via the DCF77 signal.
<b>Automatic</b>	The change takes place automatically: <ul style="list-style-type: none"> <li>– On the last weekend in March at 02:00 (daylight saving time)</li> <li>– On the last weekend in October at 03:00 (standard time)</li> </ul>
<b>Manual</b>	The <b>Daylight saving time:</b> function is not used. The time does not change automatically.
<b>Tariffs</b>	The hybrid manager uses the tariffs and the heat demand to calculate the costs for the back-up boiler and the heat pump. The more cost-effective component is used for the heat generation.
<b>Tariff for back-up boiler:</b>	Enter a gas, oil or electricity tariff. The tariff must refer to the same unit of measurement as the electricity tariff for the heat pump, e.g. ct/kWh.
<b>Electricity tariff type:</b>	Applies only for heat pumps
<b>Single tariff</b>	The costs are always calculated using the high tariff.
<b>High tariff:</b>	
<b>Dual tariff</b>	The costs are calculated using the high and low tariffs.
<b>Dual tariff weekly planner</b>	Up to twelve time periods can be set per day The <b>High tariff:</b> applies within the time periods. The <b>Low tariff:</b> applies outside of the time periods.
<b>Low tariff:</b>	
<b>Offset</b>	
<b>Room temperature: K</b>	Comparison of the temperature difference between the measured value in the system control and the value for a reference thermometer in the living room.
<b>Outdoor temperature: K</b>	Comparison of the temperature difference between the measured value in the outdoor temperature sensor and the value for a reference thermometer in the living room.
<b>Factory settings</b>	The system control resets all of the settings to the factory settings and calls up the installation assistant. Only the competent person can operate the installation assistant.

## 2.14.4 Installation configuration menu item

### MENU | SETTINGS | Installer level

<b>Installation configuration</b>	
<b>Installation</b>	
<b>Water pressure: bar</b>	Current water pressure in the heating installation
<b>eBUS components</b>	List of eBUS components and their software versions
<b>Adaptive heat curve:</b>	Automatic fine adjustment of the heat curve. Prerequisite: <ul style="list-style-type: none"> <li>– The suitable heat curve for the building is set in the <b>Heat curve:</b> function.</li> <li>– The correct zone is assigned to the system control or the remote control in the <b>Zone assignment:</b> function.</li> <li>– <b>Expanded</b> is selected in the <b>Room temp. mod.:</b> function.</li> </ul> Factory setting: <b>Deactivated</b>
<b>Automatic cooling:</b>	When a heat pump is connected, the system control automatically switches between heating mode and cooling mode. Factory setting: <b>Deactivated</b>
<b>Outdoor temp., 24 hr av.: °C</b>	Outdoor temperature averaged over the last 24 hours. The value is used by the <b>Automatic cooling:</b> function.
<b>Cooling at outdoor temp.: °C</b>	Cooling starts once the outdoor temperature (24-hour average) exceeds the set temperature. Factory setting: 15 °C

<b>Source regeneration:</b>	The system control switches the <b>Cooling</b> function on and guides the heat from the living room back to the earth via the heat pump. Prerequisite: <ul style="list-style-type: none"> <li>– The <b>Automatic cooling</b>: function has been activated.</li> <li>– The <b>Absence</b> function is active.</li> </ul> Factory setting: <b>No</b>
<b>Current room air humidity: %rel</b>	Current room air humidity, measured using the installed humidity sensor
<b>Current dew point: °C</b>	The system control calculates the current dew point in the living room.
<b>Hybrid manager:</b>	Factory setting: <b>Bival. point</b>
<b>triVAI</b>	The heat generator is selected based on the set tariffs in relation to the heat demand.
<b>Bival. point</b>	The heat generator is selected based on the outdoor temperature ( <b>Heating bivalence point: °C</b> and <b>Alternative point:</b> ).
<b>Heating bivalence point: °C</b>	If the outdoor temperature falls below the set value, the system control enables the back-up boiler to operate in parallel with the heat pump in heating mode. Prerequisite: <b>Bival. point</b> is selected in the <b>Hybrid manager</b> : function. Factory setting: -5 °C
<b>DHW bivalence point: °C</b>	If the outdoor temperature falls below the set value, the system control activates the back-up boiler in parallel with the heat pump. Factory setting: -7 °C
<b>Heating alternative point: °C</b>	If the outdoor temperature falls below the set value, the system control switches the heat pump off and the back-up boiler meets the heat demand in heating mode. Prerequisite: <b>Bival. point</b> is selected in the <b>Hybrid manager</b> : function. Factory setting: <b>Off</b>
<b>DHW alternative point: °C</b>	If the outdoor temperature falls below the set value, the system control switches the heat pump off and the back-up boiler meets the heat demand in domestic hot water mode. Factory setting: <b>Off</b>
<b>LHM temperature: °C</b>	Set a low target flow temperature. If the heat pump fails, the back-up boiler fulfils the heat demand, which leads to higher heating costs. The end user should recognise that heat loss means that there is a problem with the heat pump. The end user can use the <b>Mode: Temporary mode: Back-up heater</b> function to enable the back-up boiler and therefore deactivate the target flow temperature that is set here. Factory setting: 25 °C
<b>Back-up boiler type:</b>	Select a type for the heat generator that is also installed. An incorrect selection may lead to increased costs. Prerequisite: <b>triVAI</b> is selected in the <b>Hybrid manager</b> : function. Factory setting: <b>Condensing</b>

<b>ESCO:</b>	<p>Define what you want to deactivate when the signal is sent by the energy supply company or an external control. The selection remains deactivated until the signal is cancelled.</p> <p>The heat generator ignores the deactivation signal as soon as the frost protection function is active.</p> <p>Settings for the deactivation signal from the energy supply company:</p> <ul style="list-style-type: none"> <li>- <b>HP off</b></li> <li>- <b>Back-up heat. off</b></li> <li>- <b>HP + BUH off</b></li> </ul> <p>For the settings <b>HP off</b>, <b>Back-up heat. off</b> and <b>HP + BUH off</b>, the ESCO contact on the heat pump means the following:</p> <ul style="list-style-type: none"> <li>- closed = locked</li> <li>- open = enabled</li> </ul> <p>Settings for the deactivation signal from an installed external control:</p> <ul style="list-style-type: none"> <li>- <b>Heating off</b></li> <li>- <b>Cooling off</b></li> <li>- <b>Heat. + cool. off</b></li> </ul> <p>For the settings <b>Heating off</b>, <b>Cooling off</b> and <b>Heat. + cool. off</b>, the ESCO contact on the heat pump means the following:</p> <ul style="list-style-type: none"> <li>- closed = enabled</li> <li>- open = locked</li> </ul> <p>Factory setting: <b>HP + BUH off</b></p>
<b>ESCO contact status:</b>	Display showing whether the ESCO contact blocks or releases operation at the current time while taking into consideration the <b>ESCO:</b> function.
	<b>Blocked</b>
	<b>Enabled</b>
<b>Back-up boiler:</b>	Factory setting: <b>DHW + heat.</b>
<b>Off</b>	The back-up boiler does not support the heat pump. The back-up boiler is activated for the anti-legionella function, frost protection or de-icing.
<b>Heating</b>	The back-up boiler supports the heat pump during heating. The back-up boiler is activated for the anti-legionella function.
<b>DHW</b>	The back-up boiler supports the heat pump during domestic hot water generation. The back-up boiler is activated for frost protection or de-icing.
<b>DHW + heat.</b>	The back-up boiler supports the heat pump during domestic hot water generation and heating.
<b>Installation flow temperature: °C</b>	Measured temperature, e.g. downstream of the low loss header
<b>Buffer cylinder offset: K</b>	<p>In the case of excessive current, the buffer cylinder is heated up to the flow temperature + set offset via the heat pump. Prerequisite:</p> <ul style="list-style-type: none"> <li>- A photovoltaic installation is connected.</li> <li>- <b>Photovoltaics</b> is activated in the <b>HP control module configuration</b> → <b>MI:</b> function.</li> </ul> <p>Factory setting: 10 K</p>
<b>Actuation reversal:</b>	Prerequisite: The heating installation contains a cascade. Factory setting: <b>On</b>
<b>Off</b>	The system control always actuates the heat generators in the sequence 1, 2, 3, etc.
<b>On</b>	Once a day, the system control sorts the heat generators based on their actuation time. The back-up heater is excluded from this sorting.
<b>Actuation sequence:</b>	Sequence in which the system control actuates the heat generators. Prerequisite: The heating installation contains a cascade.

<b>Conf. ext. input:</b>	Select whether the external heating circuit is deactivated using a bridge or open terminals. Prerequisite: The FM5 and/or FM3 functional module is connected. Factory setting: <b>Bridge,deact.</b>
<b>Max. pre-heating time:</b>	Setting the time span so that the required room temperature is reached at the beginning of the first time period. The start of heating is determined as a function of the outdoor temperature (OT): – OT ≤ -20 °C: Set duration of the pre-heating time – OT ≥ +20 °C: No pre-heating time  The duration of the pre-heating time is interpolated linearly between these two values. Factory setting: <b>Off</b>
<b>DHW in casc.:</b>	Set whether the first heat pump or all heat pumps are to be used for the domestic hot water generation. Factory setting: <b>All heat pumps</b>
<b>OT constant heating:</b>	If the outdoor temperature falls below the set temperature value, <b>Heat curve:</b> is used to regulate to 20 °C outside of the time periods. OT ≤ set temperature value: No night set-back or total shut-down Factory setting: <b>Off</b>
<b>Flow temp. corr. max. value: K</b>	Setting the maximum value for the flow temperature correction. The flow temperature correction function compensates for the deviation of the system flow temperature that is not reached by increasing the target flow temperature for heat generators.
<b>Basic system diagram config.</b>	
<b>Basic system diagram code:</b>	Systems are roughly grouped according to their connected system components. Each group has a basic system diagram code. Based on the code that is entered, the system control enables the system-related functions.  You can use the connected components to determine the basic system diagram code for the installed installation (→ Using the functional modules, basic system diagram, start-up) and enter this here. Factory setting: Basic system diagram 1 or 8
<b>FM5 configuration:</b>	Each configuration corresponds to a defined FM5 terminal assignment (→ Section 4.5). The terminal assignment determines which functions contain the inputs and outputs. Select the configuration that suits the installation that is installed.
<b>FM3 configuration:</b>	Each configuration corresponds to a defined FM3 terminal assignment (→ Section 4.6). The terminal assignment determines which functions contain the inputs and outputs. Select the configuration that suits the installation that is installed.
<b>FM5 MO:</b>	Select the multi-function output's function assignment.
<b>FM3 MO:</b>	Select the multi-function output's function assignment.
<b>HP control module configuration</b>	
<b>MO 2:</b>	Select the multi-function output's function assignment. Factory setting: <b>Circulation pump</b>
<b>MI:</b>	The system control queries whether a signal is present at the heat pump's input. For example: – <b>aroTHERM</b> input: MI for the heat pump appliance interface – <b>flexoTHERM</b> input: X41, terminal in the functional drawing Factory setting: <b>1 x circulation</b>
<b>Not connected</b>	The system control ignores the signal present.
<b>1 x circulation</b>	The end user has pressed the circulation button. The system control activates the circulation pump for a short time period.
<b>Photovoltaics</b>	In the case of excessive current, a signal is present and the system control activates the <b>Hot water boost</b> function once. If the signal persists, the buffer cylinder is charged to the flow temperature + buffer cylinder offset until the signal at the heat pump drops off again.



	<b>Ext. cooling mode</b>	The signal of an external control is used to switch between heating and cooling. <ul style="list-style-type: none"> <li>- MI contact closed = cooling</li> <li>- MI contact open = heating</li> </ul>
<b>Heat generator 1</b>		
	<b>Status:</b>	Display of the current control command at the heat generator
	<b>Current flow temperature: °C</b>	Display of the current heat generator flow temperature
<b>Heat pump 1</b>		
	<b>Status:</b>	Display of the current control command at the heat pump
	<b>Current flow temperature: °C</b>	Display of the current heat pump flow temperature
<b>HP control module</b>		
	<b>Status:</b>	Display of the current control command at the back-up boiler that is connected to the heat pump appliance interface.
	<b>Current flow temperature: °C</b>	Display of the current flow temperature of the back-up boiler that is connected to the heat pump appliance interface.
<b>Circuit</b>		
	<b>Circuit type:</b>	Value setting: <b>Heating</b>
	<b>Inactive</b>	The heating circuit is not being used.
	<b>Heating</b>	The heating circuit is being used to heat and is weather-compensated. Depending on the basic system diagram, the heating circuit may be a mixing circuit or a direct circuit.
	<b>Fixed value</b>	The heating circuit is used for heating and is maintained at a fixed target flow temperature.
	<b>DHW</b>	The heating circuit is being used as a domestic hot water circuit for an additional cylinder.
	<b>Increase in return</b>	The heating circuit is used for the increase in return. The increase in return prevents an excessive temperature difference between the heating flow and return, and protects against corrosion in the floor-standing boiler when the dew point is not reached for an extended period.
	<b>Status:</b>	Display of the current operating mode
	<b>Target flow temperature: °C</b>	Target value for the heating circuit flow temperature
	<b>Actual flow temperature: °C</b>	Display of the current heating circuit flow temperature
	<b>Target return temperature: °C</b>	Select a temperature at which the heating water should flow back into the floor-standing boiler. Factory setting: 30 °C
	<b>OT switch-off threshold: °C</b>	Enter the upper limit for the outdoor temperature. If the outdoor temperature rises above the set value, the system control deactivates heating mode. Factory setting: <ul style="list-style-type: none"> <li>- 21 °C for a conventional heat generator</li> <li>- 16 °C for a heat pump</li> </ul>
	<b>Target flow temp., desired: °C</b>	Select the temperature for the fixed value circuit which applies within the time period. Factory setting: 65 °C
	<b>Target flow temp., set-back: °C</b>	Select the temperature for the fixed value circuit which applies outside of the time period. Factory setting: 0 °C
	<b>Heat curve:</b>	The heat curve is the dependence of the flow temperature on the outdoor temperature for the desired temperature (target room temperature). Detailed description of the heat curve (→ Section 2.12) Factory setting: <ul style="list-style-type: none"> <li>- 1.20 for a conventional heat generator</li> <li>- 0.60 for a heat pump and/or mixed circuit</li> </ul>
	<b>Min. target flow temperature: °C</b>	Enter the lower limit for the target flow temperature. The system control compares the set value with the calculated target flow temperature, and regulates to the larger of these values. Factory setting: 15 °C

<b>Max. target flow temperature:°C</b>	Enter the upper limit for the target flow temperature. The system control compares the set value with the calculated target flow temperature, and regulates to the smaller of these values. Factory setting: – 90 °C for a conventional heat generator – 55 °C for a heat pump and/or mixed circuit
<b>Set-back mode:</b>	The behaviour can be adjusted separately for each heating circuit. Factory setting: <b>Eco</b>
<b>Eco</b>	The heating function is switched off and the frost protection function is activated. At outdoor temperatures that are below 4 °C for longer than four hours, the system control switches the heat generator on and regulates to the <b>Set-back temperature: °C</b> . At an outdoor temperature above 4 °C, the system control switches the heat generator off. The monitoring of the outdoor temperature remains active. Heating circuit behaviour outside of the time periods. Prerequisite: – <b>Time-contr.</b> is activated in the <b>MENU   CONTROL   Zone   Heating   Mode:</b> function. – <b>Active</b> or <b>Inactive</b> is activated in the <b>Room temp. mod.:</b> function.  If <b>Expanded</b> is activated in the <b>Room temp. mod.:</b> , the system control regulates to the target room temperature 5 °C independently of the outdoor temperature.
<b>Normal</b>	The heating function is switched on. The system control regulates to the <b>Set-back temperature: °C</b> . Prerequisite: <b>Time-contr.</b> is activated in the <b>MENU   CONTROL   Zone   Heating   Mode:</b> function.
<b>Room temp. mod.:</b>	The installed temperature sensor measures the current room temperature. The system control calculates a new target room temperature that is used to adjust the flow temperature. – Difference = Set target room temperature - current room temperature – New target room temperature = Set target room temperature + difference  Prerequisite: In the <b>Zone assignment:</b> function, the system control and/or the remote control is assigned to the zone in which the system control or remote control is installed. The <b>Room temp. mod.:</b> function is ineffective if <b>No assignmt</b> is activated in the <b>Zone assignment:</b> function. Factory setting: <b>Inactive</b>
<b>Inactive</b>	
<b>Active</b>	Adjusting the flow temperature based on the current room temperature.
<b>Expanded</b>	Adjusting the flow temperature based on the current room temperature. The system control also activates/deactivates the zone. – The zone is deactivated: Current room temperature + 2/16 K > set room temperature – Zone is activated: Current room temperature < set room temperature - 3/16 K
<b>Cooling possible:</b>	Prerequisite: A heat pump is connected. Factory setting: <b>No</b>
<b>Dew point monitoring:</b>	The system control compares the set minimum cooling target flow temperature with the current dew point + set dew point offset. The system control selects the higher temperature for the target flow temperature in order to prevent condensate. Prerequisite: The <b>Cooling possible:</b> function has been activated. Factory setting: <b>Yes</b>
<b>Min. cooling targ. flow temp.: °C</b>	The system control regulates the heating circuit to the <b>Min. cooling targ. flow temp.: °C</b> . Prerequisite: The <b>Cooling possible:</b> function has been activated. Factory setting: 20 °C

<b>Dew point offset: K</b>	Safety margin that is added to the current dew point. Prerequisite: <ul style="list-style-type: none"> <li>– The <b>Cooling possible:</b> function has been activated.</li> <li>– The <b>Dew point monitoring:</b> function has been activated.</li> </ul> Factory setting: 2 K
<b>Ext. heat demand:</b>	Display showing whether a heat demand is present at an external input. When installing an FM5 or FM3 functional module, external inputs are available, depending on the configuration. You can connect an external zone controller, for example, to this external input.
<b>DHW temperature: °C</b>	Desired temperature of the domestic hot water cylinder. The heating circuit is used as a domestic hot water circuit.
<b>Actual cylinder temperature: °C</b>	Current temperature in the domestic hot water cylinder.
<b>Pump status:</b>	Display of the current control command at the heating pump.
<b>Mixing valve status: %</b>	Display of the current control command at the mixing circuit.
<b>Zone</b>	
<b>Zone activated:</b>	Deactivate zones that are not required. All existing zones appear in the display. Prerequisite: The existing heating circuits are activated in the <b>Circuit type:</b> function. Factory setting: <b>Yes</b>
<b>Zone assignment:</b>	Assign the system control and/or remote control to the selected zone. The system control and/or remote control must be installed in the selected zone. The control system also uses the room temperature sensor for the assigned unit. The remote control uses all of the values for the assigned zone. The <b>Room temp. mod.:</b> function is ineffective if you have not assigned any zones.
<b>Zone valve status:</b>	Display of the current control command at the zone valve
<b>DHW</b>	
<b>Cylinder:</b>	If there is an existing domestic hot water cylinder, the <b>Active</b> setting must be selected. Factory setting: <b>Active</b>
<b>Target flow temperature: °C</b>	Target value for the flow temperature during cylinder charging
<b>Cylinder charging pump:</b>	Display of the current control command at the cylinder charging pump
<b>Circulation pump:</b>	Display of the current control command at the circulation pump
<b>Anti-legio. day:</b>	Define the days on which you want the anti-legionella function to run. On these days, the water temperature is increased to above 60 °C. The circulation pump is activated. The function ends after 120 minutes at the latest. If the <b>Absence</b> function is activated, the anti-legionella function is not carried out. As soon as the <b>Absence</b> function ends, the anti-legionella function is carried out. Heating installations with heat pumps use the back-up boiler for legionella protection. Factory setting: <b>Off</b>
<b>Anti-legio. time:</b>	Define the time at which you want the anti-legionella function to run. Factory setting: 04:00
<b>Cylinder charging hysteresis: K</b>	Start of cylinder charging = Desired temperature – hysteresis value Factory setting: <ul style="list-style-type: none"> <li>– 5 K for a conventional heat generator</li> <li>– 7 K for a heat pump</li> </ul>
<b>Red. cyl. charging hysteresis: K</b>	Define when cylinder charging should start after a significant draw-off (e.g. showering). Start of reduced cylinder charging = Reduced domestic hot water temperature – hysteresis value Factory setting: 5 K
<b>Min. temp. after 13 hrs: °C</b>	If the cylinder temperature exceeds the set temperature value and no water has been drawn for 13 hours, cylinder charging starts. Factory setting: 43 °C
<b>Min. temp. after 24 hrs: °C</b>	If the cylinder temperature exceeds the set temperature value and no water has been drawn for 24 hours, cylinder charging starts. Factory setting: 40 °C

<b>Cylinder charging offset: K</b>	Desired temperature + offset = flow temperature for the domestic hot water cylinder. Factory setting: – 25 K for a conventional heat generator – 10 K for a heat pump
<b>Max. cyl. charging time:</b>	Setting the maximum time at which the domestic hot water cylinder can be charged without interruption. If the maximum time or the target temperature is reached, the system control enables the heating function. The <b>Off</b> setting means that the cylinder charging time is not restricted. Factory setting: – 60 mins for a conventional heat generator – 90 mins for a heat pump
<b>Cyl. charg. anti-cycl. time: min</b>	Setting the time period during which the cylinder charging is blocked after the maximum cylinder charging time has elapsed. During the blocked time, the system control enables the heating function. Factory setting: 60 min
<b>Parallel cylinder charging:</b>	When charging the domestic hot water cylinder, the mixing circuit is heated in parallel. The non-mixed heating circuit is always switched off during cylinder charging. Factory setting: <b>No</b>
<b>Buffer cylinder</b>	
<b>Cylinder temp., top: °C</b>	Actual temperature in the upper section of the buffer cylinder
<b>Cylinder temp., bottom: °C</b>	Actual temperature in the lower section of the buffer cylinder
<b>DHW temp. sensor, top: °C</b>	Actual temperature in the upper part of the domestic hot water section of the buffer cylinder
<b>DHW temp. sensor, bottom: °C</b>	Actual temperature in the lower part of the domestic hot water section of the buffer cylinder
<b>Heating temp. sensor, top: °C</b>	Actual temperature in the upper part of the heating section of the buffer cylinder
<b>Heating temp. sensor, bottom: °C</b>	Actual temperature in the lower part of the heating section of the buffer cylinder
<b>Solar cylinder, bottom: °C</b>	Actual temperature in the lower section of the solar cylinder
<b>Max. DHW targ. flow temp.: °C</b>	Setting the maximum buffer cylinder target flow temperature for the domestic hot water station. The set maximum target flow temperature must be lower than the maximum flow temperature for the heat generator. If the maximum target flow temperature is set too low, the domestic hot water station cannot reach the target temperature. While the target temperature is not reached, the system control does not enable the heat generator for heating mode. You can find the maximum flow temperature in the installation instructions for the heat generator. Factory setting: – 80 °C – 65 °C if basic system diagram 8 is selected
<b>Max. temp. of cylinder 1: °C</b>	Setting the maximum cylinder temperature. The solar circuit stops the cylinder charging as soon as the maximum cylinder temperature has been reached. Factory setting: 75 °C
<b>Solar circuit</b>	
<b>Collector temperature: °C</b>	Display of the current temperature at the solar collector
<b>Solar pump:</b>	Display of the current control command at the solar pump
<b>Solar yield sensor: °C</b>	Display of the current temperature at the solar yield sensor
<b>Solar flow rate quantity:</b>	Entering the volume flow to calculate the solar yield. If a solar pump station is installed, the system control ignores that value that has been entered and uses the volume flow that is supplied from the solar pump station. The value 0 means the automatic recording of the volume flow. Factory setting: <b>Auto</b>

<b>Solar pump kick:</b>	Accelerated recording of the collector temperature. When the function is activated, the solar pump is switched on for a short time and the heated solar fluid is transported to the measuring point more quickly. Factory setting: <b>Off</b>
<b>Solar circuit prot. function: °C</b>	Setting the maximum temperature that must not be exceeded in the solar circuit. If the maximum temperature at the collector sensor is exceeded, the solar pump switches off to protect the solar circuit against overheating. Factory setting: 130 °C
<b>Min. collector temperature: °C</b>	Setting the minimum collector temperature that is required for the solar charging switch-on differential. The differential temperature control can only start once the minimum collector temperature has been reached. Factory setting: 20 °C
<b>Purging time: min</b>	Setting the time period during which the solar circuit is purged. The system control stops the function once the specified purging time has elapsed, the solar circuit protection function is active or the max. cylinder temperature has been exceeded. Factory setting: 0 min
<b>Current flow rate: l/min</b>	Current volume flow of the solar pump station
<b>Solar cylinder 1</b>	
<b>Switch-on differential: K</b>	Setting the differential value for starting the solar charging. If the temperature difference between the cylinder temperature sensor at the bottom and the collector temperature sensor is greater than the set differential value and the set minimum collector temperature, the cylinder charging is started. The differential value can be defined separately for two connected solar cylinders. Factory setting: 12 K
<b>Switch-off differential: K</b>	Setting the differential value for stopping the solar charging. If the temperature difference between the bottom cylinder temperature sensor and the collector temperature sensor is smaller than the set differential value and the set minimum collector temperature, the cylinder charging is stopped. The switch-off differential temperature value must be at least 1 K less than the set switch-on differential temperature value. Factory setting: 5 K
<b>Maximum temperature: °C</b>	Set the maximum cylinder charging temperature for the cylinder protection. If the temperature at the bottom cylinder temperature sensor is higher than the set maximum cylinder charging temperature, the solar charging is interrupted. The solar charging is only enabled again once the temperature at the bottom cylinder temperature sensor has fallen by between 1.5 K and 9 K, depending on the maximum temperature. The set maximum temperature must not exceed the maximum permissible cylinder temperature of the cylinder. Factory setting: 75 °C
<b>Solar cylinder, bottom: °C</b>	Display of the current temperature in the lower section of the solar cylinder
<b>2nd diff. temp. control</b>	
<b>Switch-on differential: K</b>	Setting the differential value for starting the differential temperature control, such as solar heating support. If the temperature difference between differential temperature sensor 1 and differential temperature sensor 2 is greater than the set switch-on differential and the set minimum temperature at differential temperature sensor 1, the differential temperature control is started. Factory setting: 12 K
<b>Switch-off differential: K</b>	Setting the differential value for stopping the temperature difference control, such as solar heating support. If the temperature difference between differential temperature sensor 1 and differential temperature sensor 2 is lower than the set switch-off differential and the set maximum temperature at differential temperature sensor 2, the differential temperature control is stopped. Factory setting: 5 K

<b>Minimum temperature: °C</b>	Setting the minimum temperature for starting the differential temperature control. Factory setting: 0 °C
<b>Maximum temperature: °C</b>	Setting the maximum temperature for stopping the differential temperature control. Factory setting: 99 °C
<b>Diff. temp. sensor 1:</b>	Display of the current temperature at differential temperature sensor 1
<b>Diff. temp. sensor 2:</b>	Display of the current temperature at differential temperature sensor 2
<b>Diff. temp. sens. output:</b>	Display of the current control command at the connected actuator
<b>Screed drying profile</b>	Setting target flow temperature per day in accordance with the construction regulations

### 3 -- Electrical installation, set-up

Only qualified electricians may carry out the electrical installation.

The heating installation must be decommissioned before work is carried out on it.

#### 3.1 Determining the system control's installation site

**Condition:** Working **Adaptive heat curve:**, **Room temp. mod.:**, **Dew point monitoring:**, **Zone assignment:**

- ▶ Install the system control in a living room in the selected zone.

**Condition:** Not working **Adaptive heat curve:**, **Room temp. mod.:**, **Dew point monitoring:**, **Zone assignment:**

- ▶ Install the system control in a suitable room, in which the end user can operate the system control well.

#### 3.2 Requirements for the eBUS line

Observe the following rules when routing the eBUS lines:

- ▶ Use twin-core cables.
- ▶ Never use shielded or twisted cables.
- ▶ Use only appropriate cables, e.g. NYM or H05VV (-F/-U).
- ▶ Observe the permissible total length of 125 m. For a total length of up to 50 m, a conductor cross-section of  $\geq 0.75 \text{ mm}^2$  applies; from 50 m upwards, a conductor cross-section of  $1.5 \text{ mm}^2$  applies.

In order to prevent faults in the eBUS signals (e.g. due to interferences):

- ▶ Maintain a minimum clearance of 120 mm to power supply cables or other electromagnetic sources of interference.
- ▶ For parallel routing to mains connection lines, guide the cables in accordance with the applicable regulations, e.g. on cable trays.
- ▶ **Exceptions:** For wall breaks and in the electronics box, it is acceptable to not reach the minimum clearance.

#### 3.3 Requirements for the sensor cable

Observe the following rules when routing the sensor lines:

- ▶ Use twin-core cables.
- ▶ Never use shielded or twisted cables.
- ▶ Use only appropriate cables, e.g. NYM or H05VV (-F/-U).
- ▶ Observe the permissible total length of 50 m.

In order to prevent faults in the sensor signals (e.g. due to interferences):

- ▶ Maintain a minimum clearance of 120 mm to power supply cables or other electromagnetic sources of interference.
- ▶ For parallel routing to mains connection lines, guide the cables in accordance with the applicable regulations, e.g. on cable trays.
- ▶ **Exceptions:** For wall breaks and in the electronics box, it is acceptable to not reach the minimum clearance.

#### 3.4 Connecting the system control

- ▶ Connect the eBUS line to the eBUS terminals in the system control's wall base.

##### 3.4.1 Connecting a system control to the heat generator

- ▶ Connect the eBUS line to the heat generator's eBUS terminals, as described in the installation instructions for the heat generator and in Basic system diagram and wiring diagram (→ Section 4.9.1).

##### 3.4.2 Connecting a system control to the ventilation unit

1. Connect the system control to the ventilation unit as described in the installation instructions for the ventilation unit.

**Condition:** Ventilation unit connected to the eBUS without **VR 32**, Ventilation unit without eBUS heat generator

- ▶ Connect the eBUS line to the eBUS terminals in the system control's wall base.
- ▶ Connect the eBUS line to the eBUS terminals on the ventilation unit.

**Condition:** Ventilation unit connected to the eBUS with **VR 32**, Ventilation unit with up to two eBUS heat generators

- ▶ Connect the eBUS line to the eBUS terminals in the system control's wall base.
- ▶ Connect the eBUS line to the eBUS of the heat generator.
- ▶ Set the address switch for the **VR 32** in the ventilation unit to position 3.

**Condition:** Ventilation unit connected to the eBUS with **VR 32**, Ventilation unit with more than two eBUS heat generators

- ▶ Connect the eBUS line to the eBUS terminals in the system control's wall base.
- ▶ Connect the eBUS line to the common eBUS on the heat generator.
- ▶ Determine the highest possible position on the address switches of the **VR 32** for the connected heat generator.
- ▶ Set the address switch of the **VR 32** in the ventilation unit to the second highest position.

### 3.5 Installing the system control and outdoor temperature sensor

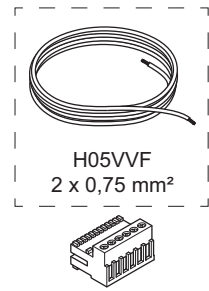
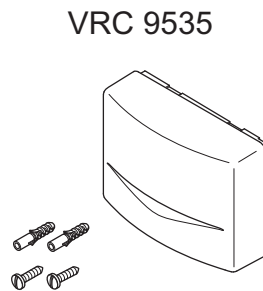
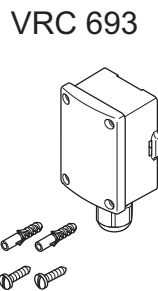
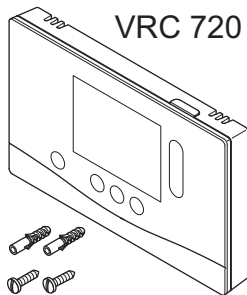
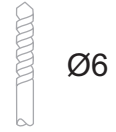
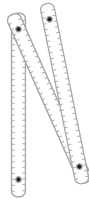

VRC 720

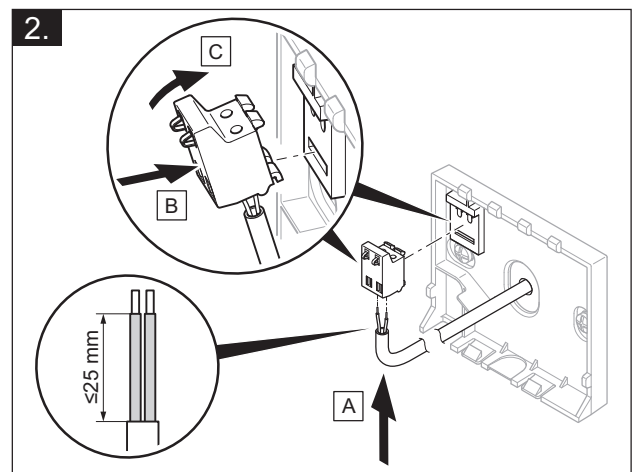
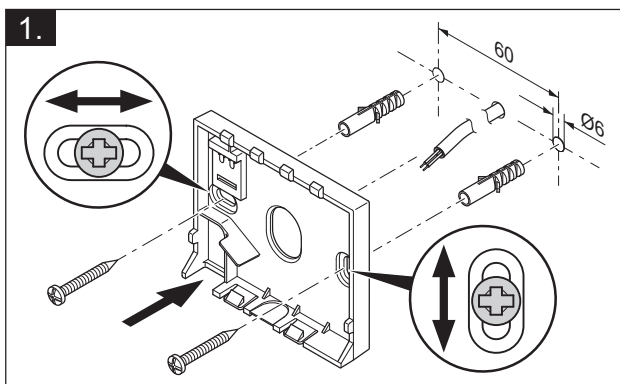
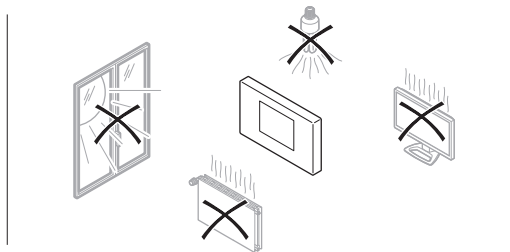
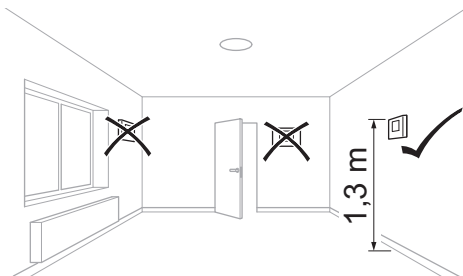



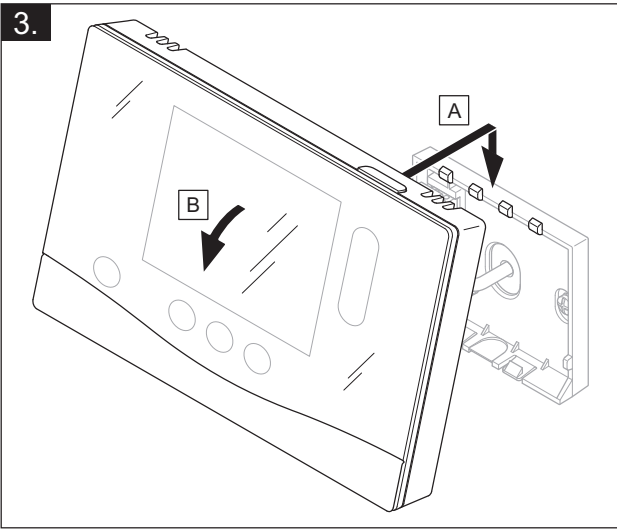

VRC 693, VRC 9535

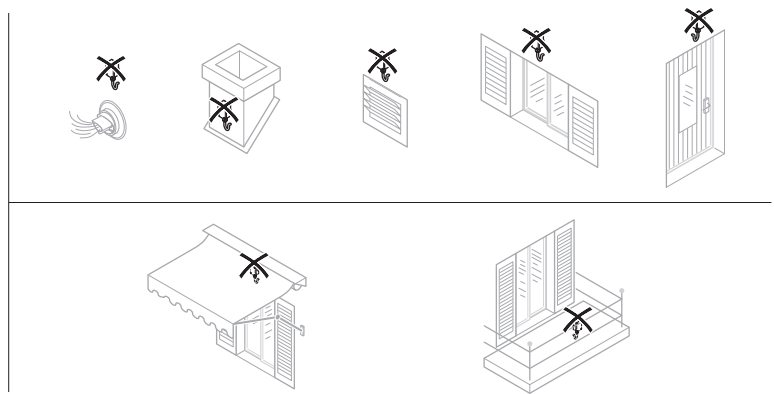
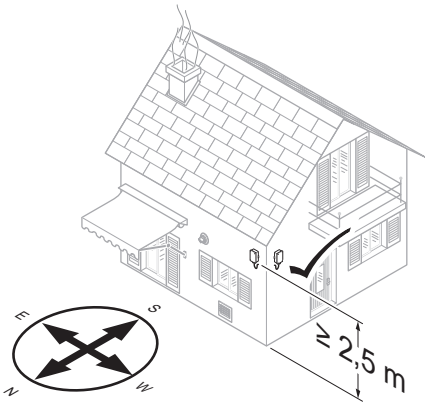

VRC 693

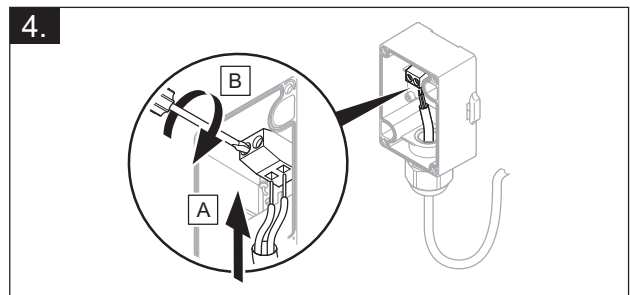
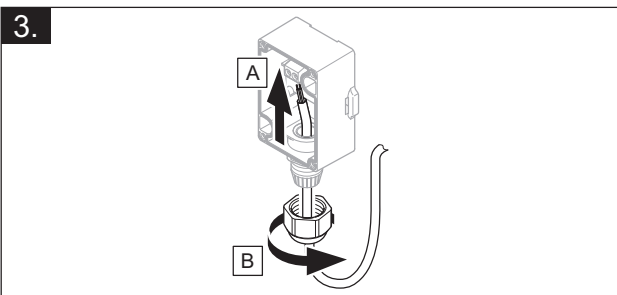
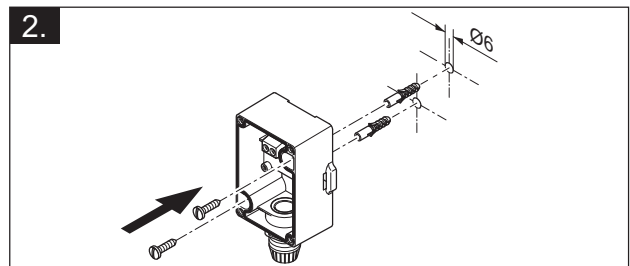
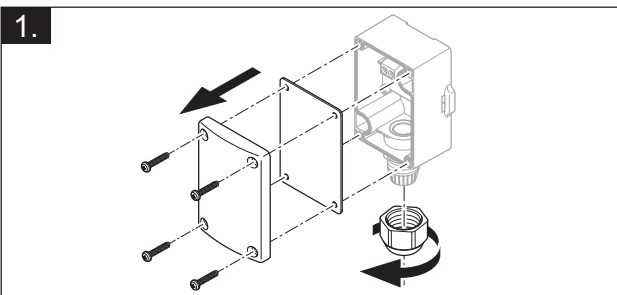

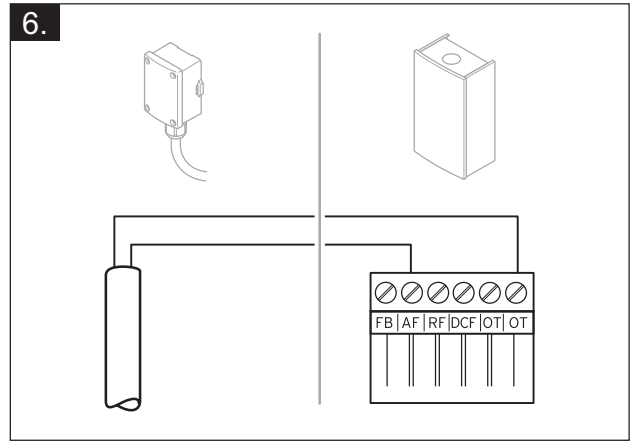
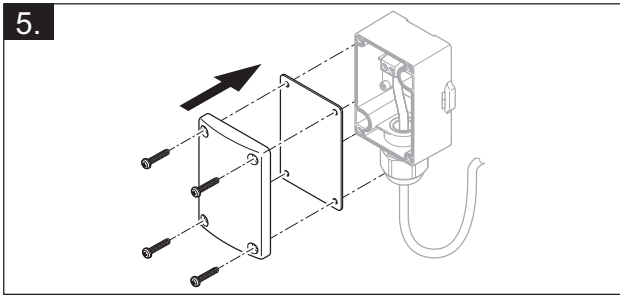

VRC 9535

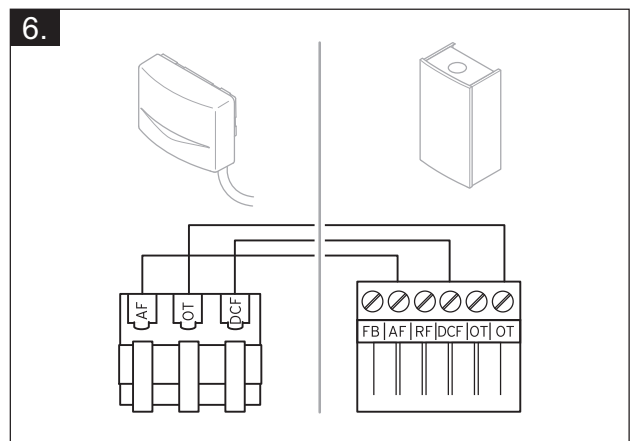
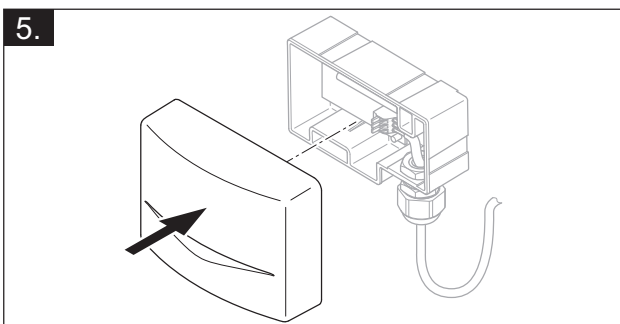
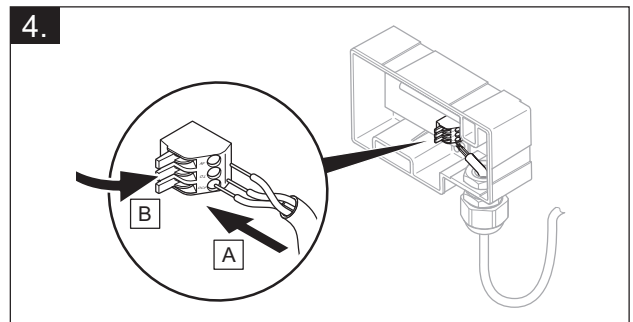
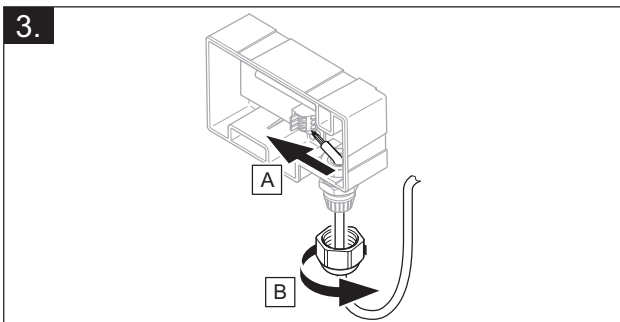
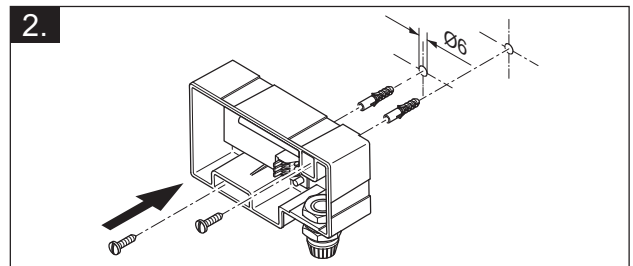
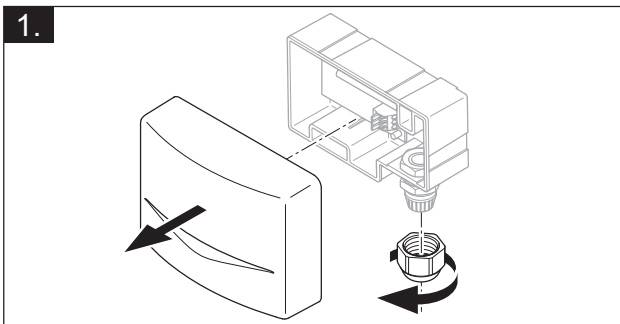

## 4 -- Using the functional modules, basic system diagram, start-up

### 4.1 System without functional modules

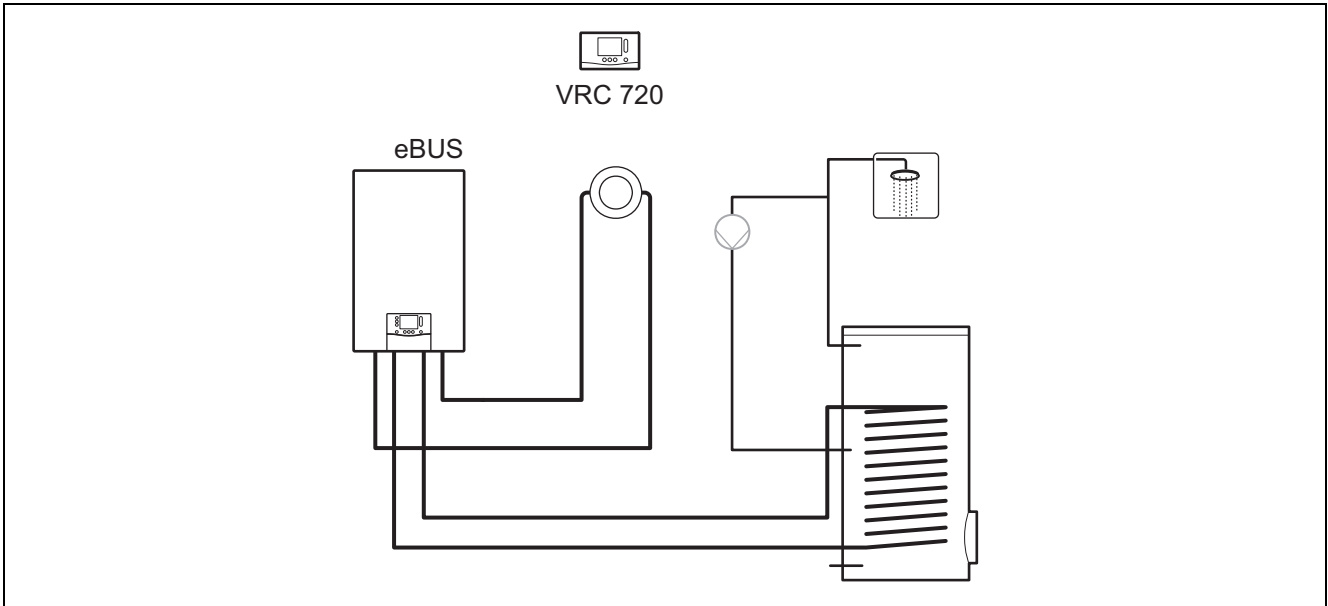

Simple systems with a direct heating circuit do not require a functional module.

### 4.2 System with FM3 functional module

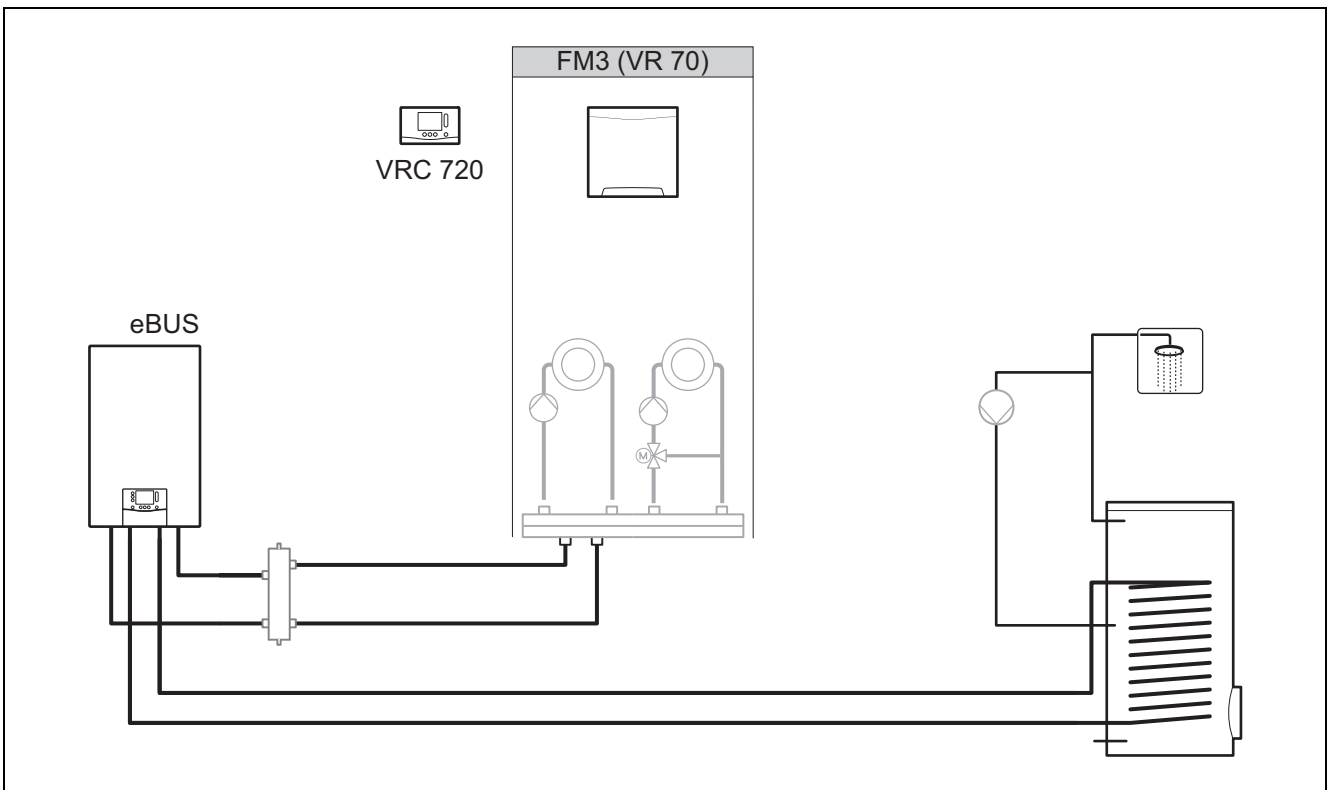

Systems with two heating circuits that must be controlled separately from each other require the FM3 functional module.

The **VR 92** remote control cannot be added to the system.

### 4.3 System with FM5 and FM3 functional modules

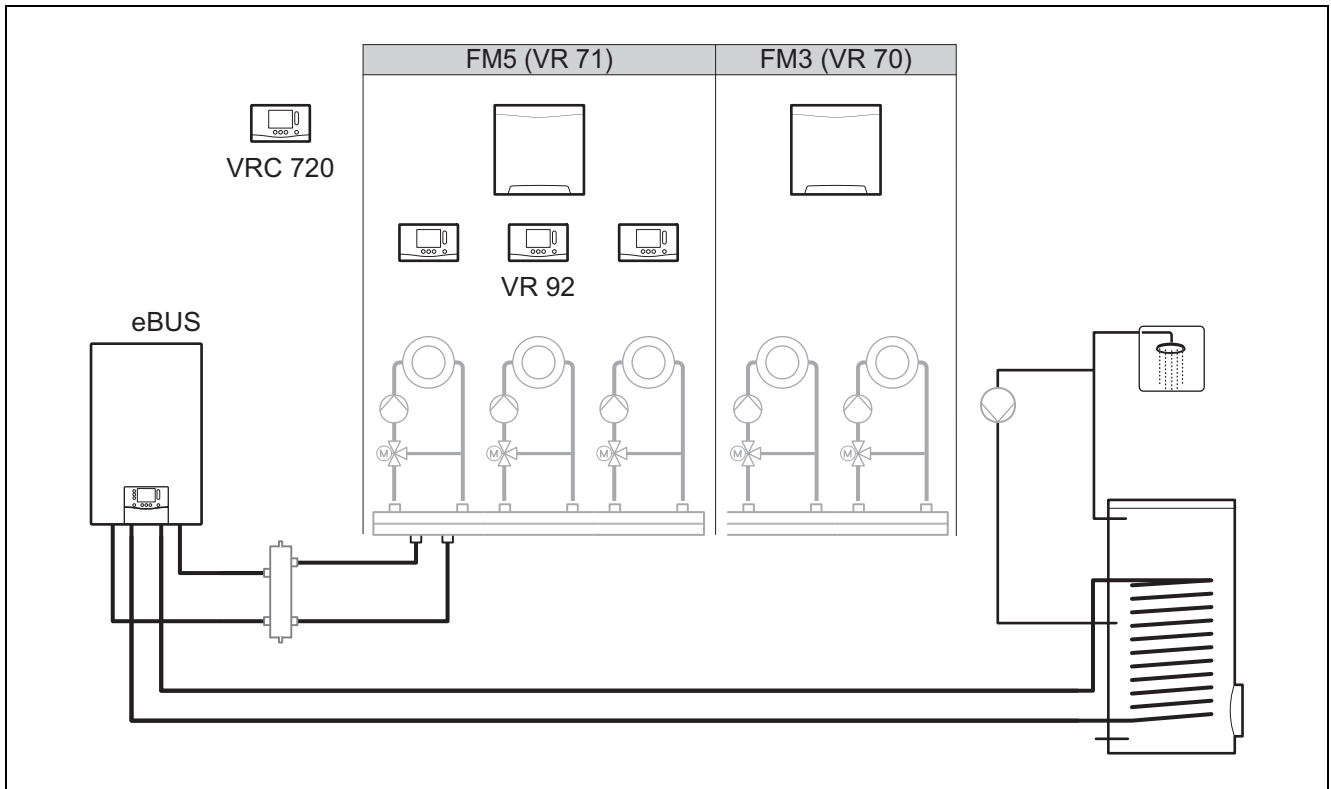

Systems with more than two mixed heating circuits require the FM5 functional module.

The system may comprise the following:

- Maximum 1 x FM5 functional module
- Maximum 3 x FM3 functional modules, in addition to the FM5 functional module
- Maximum 4 x **VR 92** remote controls, which can be installed in each heating circuit
- Maximum 9 x heating circuits, which you achieve using 1 x FM5 functional module and 3 x FM3 functional modules

### 4.4 Potential application for the functional modules

#### 4.4.1 FM5 functional module

Each configuration corresponds to a defined connection assignment of the FM5 (→ Section 4.5) functional module.

Configura-tion	System property	Mixed heat-ing circuits
1	Solar heating and/or domestic hot water support with two solar cylinders	Max. 2
2	Solar heating and/or domestic hot water support with one solar cylinder	Max. 3
3	3 x mixed heating circuits	Max. 3
6	<b>aIISTOR</b> multi-functional buffer cylinder and domestic hot water station	Max. 3

#### 4.4.2 FM3 functional module

If a FM3 functional module is installed, the system has one mixed and one non-mixed heating circuit.

The potential configuration (FM3) corresponds to a defined terminal assignment for the FM3 (→ Section 4.6) functional module.

### 4.4.3 FM3 and FM5 functional modules

If the FM3 and FM5 functional modules are installed in a system, each additional installed FM3 functional module adds two mixed heating circuits to the system.

The potential configuration (FM3+FM5) corresponds to a defined terminal assignment for the FM3 (→ Section 4.6) functional module.

### 4.5 Connection assignment for the FM5 functional module

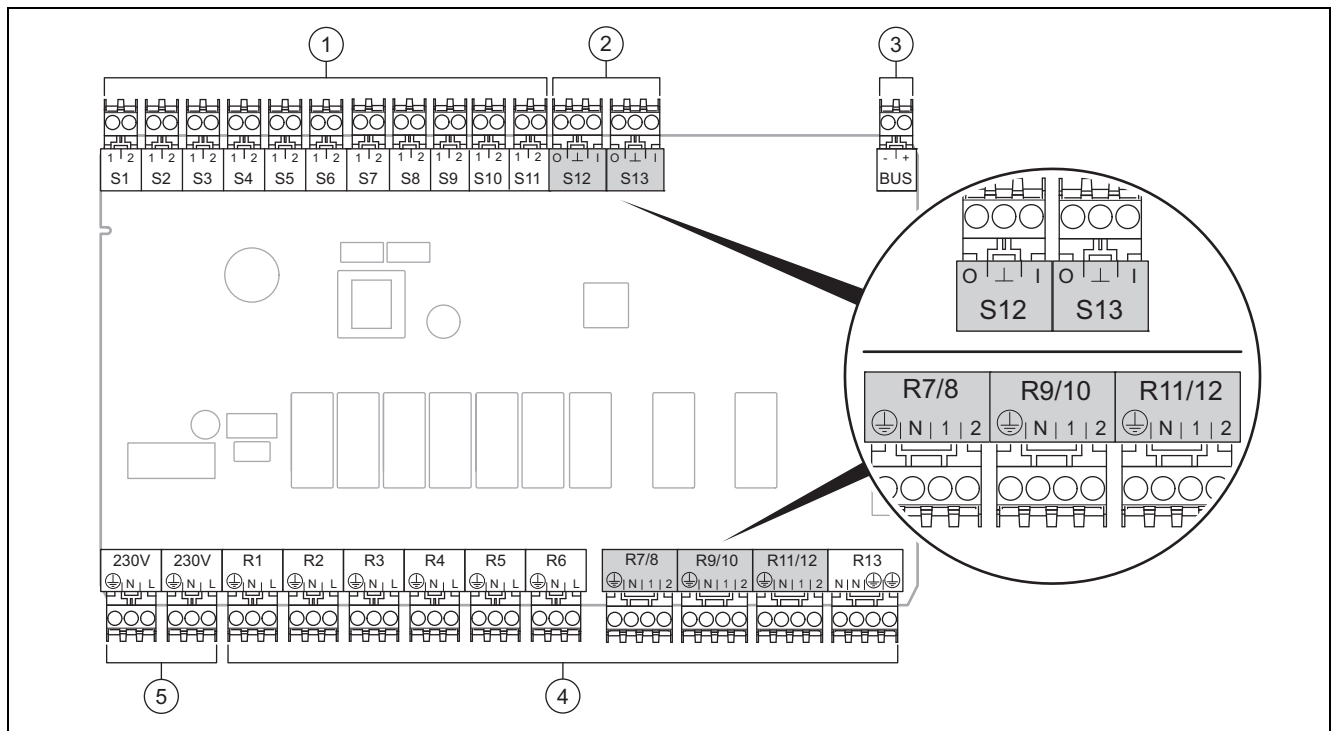

- |   |                        |   |                        |
|---|------------------------|---|------------------------|
| 1 | Input sensor terminals | 4 | Output relay terminals |
| 2 | Signal terminals       | 5 | Power supply           |
| 3 | eBUS terminal          |   |                        |
- When connecting, pay attention to the polarity!

S6 to S11 sensor terminals: An external control can also be connected

S12, S13 signal terminals: I = input, O = output

R7/8, R9/10, R11/12 mixer output: 1 = open, 2 = closed

You can configure the contacts for external inputs in the system control.

- **Open, deact.:** Contacts open, no heat demand
- **Bridge, deact.:** Contacts closed, no heat demand

Configur- ation	R1	R2	R3	R4	R5	R6	R7/R8	R9/R10	R11/R12	R13
1	3f1	3f2	9gSolar	MO	3j	3c/9e	9k1op/ 9k1cl	9k2op/ 9k2cl	–	–
2	3f1	3f2	3f3	MO	3j	3c/9e	9k1op/ 9k1cl	9k2op/ 9k2cl	9k3op/ 9k3cl	–
3	3f1	3f2	3f3	MO	–	3c/9e	9k1op/ 9k1cl	9k2op/ 9k2cl	9k3op/ 9k3cl	–
6	3f1	3f2	3f3	MO	9gSolar	3c/9e	9k1op/ 9k1cl	9k2op/ 9k2cl	9k3op/ 9k3cl	–

Configur- ation	S1	S2	S3	S4	S5	S6	S7	S8	S9	S10	S11	S12	S13
1	SysFlow	FS1	FS2	DHW Bt2	DHW	DHWBt	COL	Solar yield	DEM2	TD1	TD2	PWM	–
2	SysFlow	FS1	FS2	FS3	DHW	DHWBt	COL	Solar yield	–	TD1	TD2	PWM	–
3	SysFlow	FS1	FS2	FS3	BufBt	DEM1	DEM2	DEM3	DHW	–	–	–	–

Configuration	S1	S2	S3	S4	S5	S6	S7	S8	S9	S10	S11	S12	S13
6	SysFlow	FS1	FS2	FS3	BufBt	BufBtCH	BufTop DHW	BufBt DHW	DEM1	DEM2	DEM3	DHW Bt2	-

Meaning of the abbreviations (→ Section 4.9.1)

### Sensor assignment

Configuration	S1	S2	S3	S4	S5	S6	S7	S8	S9	S10	S11	S12	S13
1	VR 10	VR 10	VR 10	VR 10	VR 10	VR 10	VR 11	VR 10	-	VR 10	VR 10	-	-
2	VR 10	VR 10	VR 10	VR 10	VR 10	VR 10	VR 11	VR 10	-	VR 10	VR 10	-	-
3	VR 10	VR 10	VR 10	VR 10	VR 10	-	-	-	VR 10	VR 10	-	-	-
6	VR 10	VR 10	VR 10	VR 10	VR 10	VR 10	VR 10	VR 10	-	-	-	VR 10	-

## 4.6 Connection assignment for the FM3 functional module

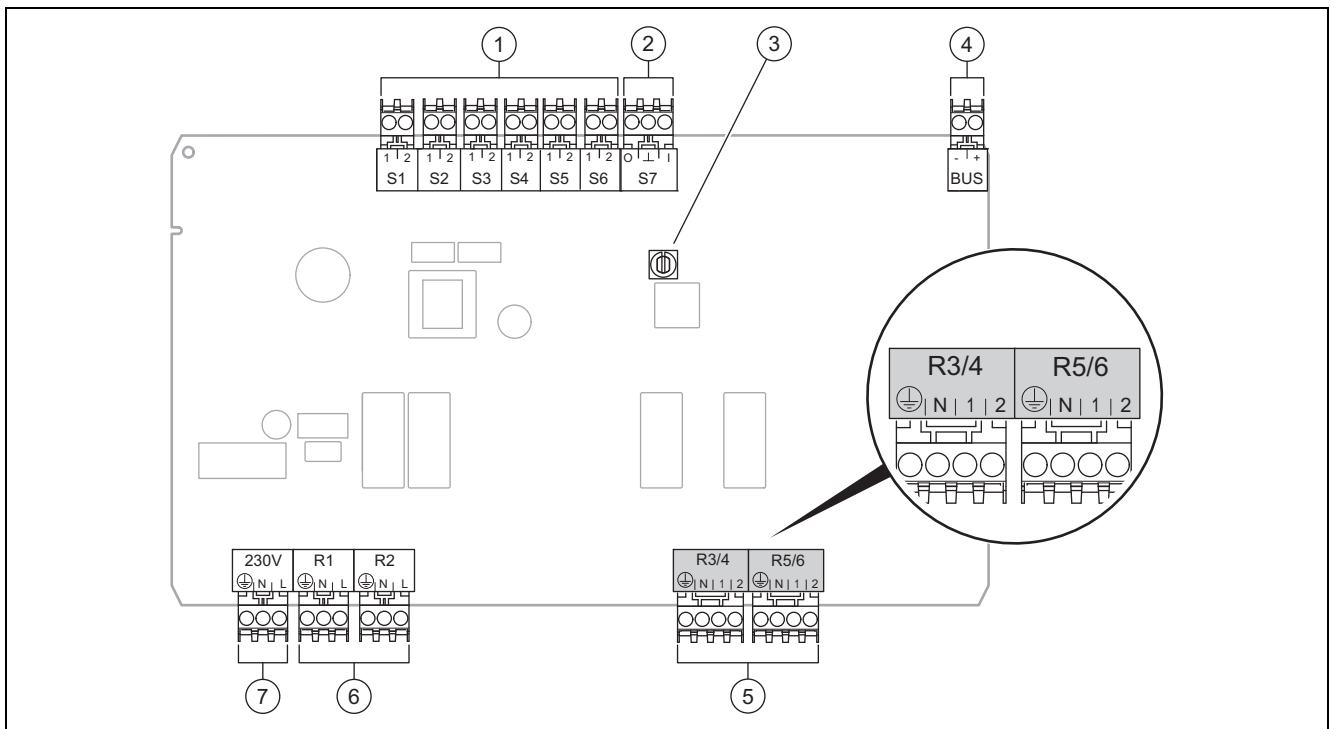

1	Input sensor terminals	5	Mixer output
2	Signal terminal	6	Output relay terminals
3	Address switch	7	Power supply
4	eBUS terminal		

S2, S3 sensor terminals: An external control can also be connected

R3/4, R5/6 mixer output: 1 = open, 2 = closed

You can configure the contacts for external inputs in the system control.

- **Open, deact.:** Contacts open, no heat demand
- **Bridge, deact.:** Contacts closed, no heat demand

Configuration	R1	R2	R3/R4	R5/R6	S1	S2	S3	S4	S5	S6	S7
FM3+FM5	3fa	3fb	9kaop/ 9kacl	9kbop/ 9kbcl	-	DEMa	DEMb	-	FSa	FSb	-
FM3	3f1	3f2	MO	9k2op/ 9k2cl	BufBt/ DHW	DEM1	DEM2	-	SysFlow	FS2	-

Meaning of the abbreviations (→ Section 4.9.1)

## Sensor assignment

Configuration	S1	S2	S3	S4	S5	S6	S7
FM3+FM5	–	–	–	–	VR 10	VR 10	–
FM3	VR 10	–	–	–	VR 10	VR 10	–

### 4.7 Settings for the basic system diagram codes

The systems are roughly grouped according to their connected system components. Each grouping contains a basic system diagram code that you must enter in the **Basic system diagram code**: function in the system control. The system control requires the basic system diagram code in order to enable the system-related functions.

#### 4.7.1 Gas- or oil-fired boiler as a single unit

System property	Basic system diagram code:
allSTOR cylinder system incl. domestic hot water station	1
Boilers with solar domestic hot water support	1
All boilers without solar	1
– Connecting the domestic hot water cylinder temperature sensor to the boiler	
Exceptions:	
Boilers without solar	2 <sup>1)</sup>
– Connecting the domestic hot water cylinder temperature sensor to the functional module	
Boiler with solar heating and hot water support	2 <sup>1)</sup>
1) Do not use the integrated prioritising diverter valve from the <b>ecoTEC VC</b> boiler (permanent position: Heating mode).	

#### 4.7.2 Cascade with gas- or oil-fired boilers

Maximum seven boilers possible

As of the second boiler, the boilers are connected via **VR 32** (address 2 to 7).

System property	Basic system diagram code:
Domestic hot water generation provided by a selected boiler (isolating circuit)	1
– Domestic hot water generation provided by the boiler with the highest address	
– Connecting a domestic hot water cylinder temperature sensor to this boiler	
Domestic hot water generation provided by the whole cascade (no isolating circuit)	2 <sup>1)</sup>
– Connecting the domestic hot water cylinder temperature sensor to the FM5 functional module	
allSTOR cylinder system incl. domestic hot water station	2 <sup>1)</sup>
1) Do not use the integrated prioritising diverter valve from the <b>ecoTEC VC</b> boiler (permanent position: Heating mode).	

#### 4.7.3 Heat pump as a single unit (monoenergetic)

With immersion heater in the flow as a back-up boiler

System property	Basic system diagram code:	
	Without heat exchanger <sup>1)</sup>	With heat exchanger <sup>1)</sup>
Without solar	8	11
– Connecting the domestic hot water cylinder temperature sensor to the heat pump control module and/or heat pump		
With solar domestic hot water support	8	11
allSTOR cylinder system incl. domestic hot water station	8	16
1) E.g. <b>VWZ MWT</b>		

#### 4.7.4 Heat pump as a single unit (hybrid)

With external back-up boiler

A back-up boiler (with eBUS) is connected via the **VR 32** (address 2).

A back-up boiler (without eBUS) is connected to the output for the heat pump or the heat pump control module for the external back-up boiler.

System property	Basic system diagram code:	
	Without heat ex-changer <sup>1)</sup>	With heat exchanger <sup>1)</sup>
Domestic hot water generation only provided by the back-up boiler without the functional module – Connecting the domestic hot water cylinder temperature sensor to a back-up boiler (separate charge control)	8	10
Domestic hot water generation only provided by the back-up boiler with the functional module – Connecting the domestic hot water cylinder temperature sensor to a back-up boiler (separate charge control)	9	10
Domestic hot water generation through the heat pump and back-up boiler – Connecting the domestic hot water cylinder temperature sensor to the FM5 functional module – Without the FM5 functional module, connecting the domestic hot water cylinder temperature sensor to the heat pump control module and/or heat pump	16	16
Domestic hot water generation provided by the heat pump and back-up boiler with a bivalent domestic hot water cylinder – Connecting the upper domestic hot water cylinder temperature sensor to a back-up boiler (separate charge control) – Connecting the lower domestic hot water cylinder temperature sensor to the heat pump control module and/or heat pump	12	13
1) E.g. <b>VWZ MWT</b>		

#### 4.7.5 Cascade with heat pumps

Maximum seven heat pumps possible

With external back-up boiler

As of the second heat pump, the heat pumps and, if required, the heat pump control modules, are connected via the **VR 32 (B)** (address 2 to 7).

A back-up boiler (with eBUS) is connected via the **VR 32** (next free address).

A back-up boiler (without eBUS) is connected to the output for the first heat pump or the heat pump control module for the external back-up boiler.

System property	Basic system diagram code:	
	Without heat ex-changer <sup>1)</sup>	With heat exchanger <sup>1)</sup>
Domestic hot water generation provided by the back-up boiler only – Connecting the domestic hot water cylinder temperature sensor to a back-up boiler (separate charge control)	9	–
Domestic hot water generation through the heat pump and back-up boiler – Connecting the domestic hot water cylinder temperature sensor to the FM5 functional module	16	16
1) E.g. <b>VWZ MWT</b>		



## 4.8 Combinations of basic system diagram and configuration of functional modules

You can use the table to check the selected combination of the basic system diagram code and the configuration of functional modules.

Basic system diagram code:	System	Without FM5, without FM3	With FM3	With FM5						With FM5 + Max. 3 x FM3
				Configuration						
				1	2	1	2	3	6	
		Solar domestic hot water generation		Solar heating support						
For conventional heat generators										
1	Gas-/oil-fired boiler	x	x <sup>1)</sup>	x	x	–	–	x <sup>1)</sup>	x <sup>1)</sup>	x
	Gas-/oil-fired boiler, cascade	–	–	–	–	–	–	x <sup>1)</sup>	–	x
2	Gas-/oil-fired boiler	–	x <sup>1)</sup>	–	–	x	x	x <sup>1)</sup>	–	x
	Gas-/oil-fired boiler, cascade	–	–	–	–	–	–	x <sup>1)</sup>	x <sup>1)</sup>	x
For heat pump systems										
8	Monoenergetic heat pump system	x	x <sup>1)</sup>	x	x	–	–	x <sup>1)</sup>	x <sup>1)</sup>	x
	Hybrid system	x	–	–	–	–	–	–	–	–
9	Hybrid system	–	x <sup>1)</sup>	–	–	–	–	x <sup>1)</sup>	–	x
	Cascade of heat pumps	–	–	–	–	–	–	x <sup>1)</sup>	–	x
10	Mono-energy heat pump system with heat exchanger <sup>2)</sup>	x	x <sup>1)</sup>	–	–	–	–	x <sup>1)</sup>	–	x
	Hybrid system with heat exchanger <sup>2)</sup>	x	x <sup>1)</sup>	–	–	–	–	x <sup>1)</sup>	–	x
11	Mono-energy heat pump system with heat exchanger <sup>2)</sup>	x	x <sup>1)</sup>	x	x	–	–	x <sup>1)</sup>	–	x
12	Hybrid system	x	x <sup>1)</sup>	–	–	–	–	x <sup>1)</sup>	–	x
13	Hybrid system with heat exchanger <sup>2)</sup>	–	x <sup>1)</sup>	–	–	–	–	x <sup>1)</sup>	–	x
16	Hybrid system with heat exchanger <sup>2)</sup>	–	x <sup>1)</sup>	–	–	–	–	x <sup>1)</sup>	x <sup>1)</sup>	x
	Cascade of heat pumps	–	–	–	–	–	–	x <sup>1)</sup>	x <sup>1)</sup>	x
	Mono-energy heat pump system with heat exchanger <sup>2)</sup>	x	x <sup>1)</sup>	–	–	–	–	x <sup>1)</sup>	x <sup>1)</sup>	x
x: Combination possible –: Combination not possible 1) Buffer management possible 2) E.g. <b>VWZ MWT</b>										

## 4.9 Basic system diagram and wiring diagram

### 4.9.1 Meaning of the abbreviations

Abbreviation	Meaning
1	Heat generator
1a	Domestic hot water back-up boiler
1b	Heating back-up boiler
1c	Domestic hot water/heating back-up boiler
2a	Air-to-water heat pump
2c	Refrigerant-split heat pump outdoor unit
2d	Refrigerant-split heat pump indoor unit
3	Heat generator circulation pump
3a	Swimming pool circulation pump
3c	Cylinder charging pump
3e	Circulation pump
3f[x]	Heating pump
3h	Anti-legionella pump
3i	Pump heat exchanger
3j	Solar pump
4	Buffer cylinder
5	Monovalent domestic hot water cylinder
5a	Bivalent domestic hot water cylinder
5e	Hydraulic tower
6	Solar collector (thermal)
7a	Heat pump brine filling unit
7b	Solar pump station
7d	Heat interface unit
7f	Decoupler module
7g	Heat recovery module
7h	Heat exchanger module
7i	2-zone module
7j	Pump group
8a	Expansion relief valve
8b	Potable water expansion relief valve
8c	Safety assembly – potable water connection
8d	Safety assembly for the heat generator
8e	Heating diaphragm expansion vessel
8f	Diaphragm expansion vessel – potable water
8g	Solar/brine diaphragm expansion vessel
8h	Solar protection vessel
8i	Thermal safety assembly
9a	Single-room temperature control valve (thermostatic/motorised)
9b	Zone valve
9c	Flow regulator valve
9d	Bypass valve
9e	Diverter valve for potable water
9f	Diverter valve, cooling
9g	Diverter valve
9gSolar	Solar diverter valve
9h	Filling/draining cock
9i	Purging valve

Abbreviation	Meaning
9j	Tamper-proof capped valve
9k[x]	3-port mixing valve
9l	Cooling 3-port mixing valve
9n	Thermostatic mixing valve
9o	Flow meter (TacoSetter)
9p	Cascade valve
10a	Thermometer
10b	Manometer
10c	Non-return valve
10d	Air separator
10e	Line strainer with magnetite separator
10f	Solar/brine collecting vessel
10g	Heat exchanger
10h	Low loss header
10i	Flexible connections
11a	Fan coil
11b	Swimming pool
12	System control
12a	Remote control
12b	Heat pump control module
12c	2 in 7 multi-functional module
12d	FM3 functional module
12e	FM5 functional module
12f	Wiring centre
12g	eBUS bus coupler
12h	Solar control
12i	External control
12j	Cut-off relay
12k	Limit thermostat
12l	Cylinder temperature cut-out
12m	Outdoor temperature sensor
12n	Flow switch
12o	eBUS power supply unit
12p	Radio receiver unit
12q	Internet module
12r	PV control
C1/C2	Enable cylinder charging/buffer cylinder charging
COL	Collector temperature sensor
DEM[x]	External heat demand for the heating circuit
DHW	Cylinder temperature sensor
DHWBt	Bottom cylinder temperature sensor (domestic hot water cylinder)
DHWBt2	Cylinder temperature sensor (second solar cylinder)
EVU	Energy supply company switching contact
FS[x]	Flow temperature sensor for heating circuit/swimming pool sensor
MA	Multi-function output
ME	Multi-function input
PV	Photovoltaic inverter interface
PWM	PWM signal for pump

Abbreviation	Meaning
RT	Room thermostat
SCA	Cooling signal
SG	Transmission system operator interface
Solar yield	Solar yield sensor
SysFlow	System temperature sensor
TD1, TD2	Temperature sensor for a differential temperature control
TEL	Switch contact for remote control
TR	Isolating circuit with switching floor-standing boiler

## **4.9.2 Basic system diagram 0020184677**

### **4.9.2.1 Setting on the system control**

**Basic system diagram code: 1**

### 4.9.2.2 Basic system diagram 0020184677

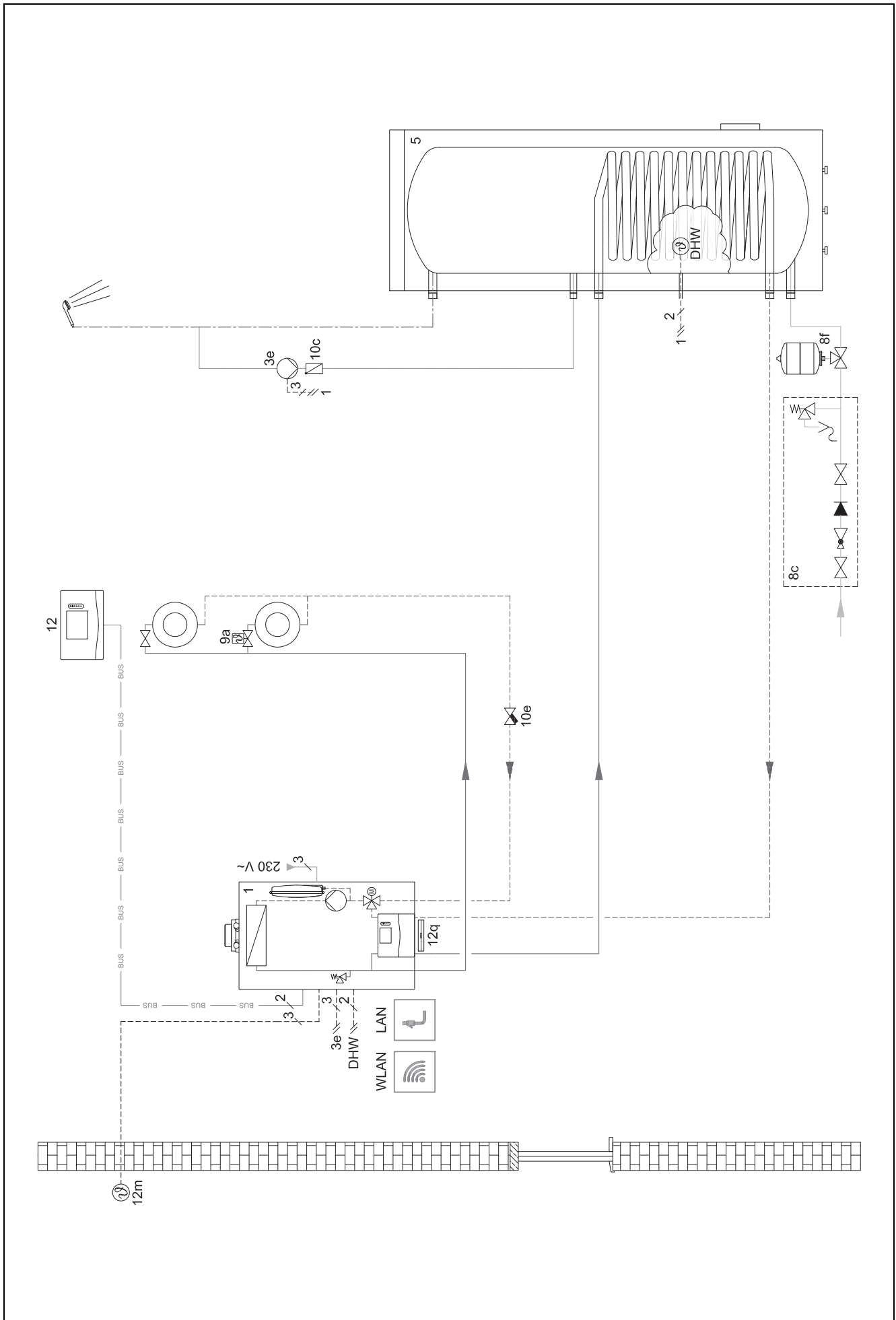

4.9.2.3 Wiring diagram 0020184677

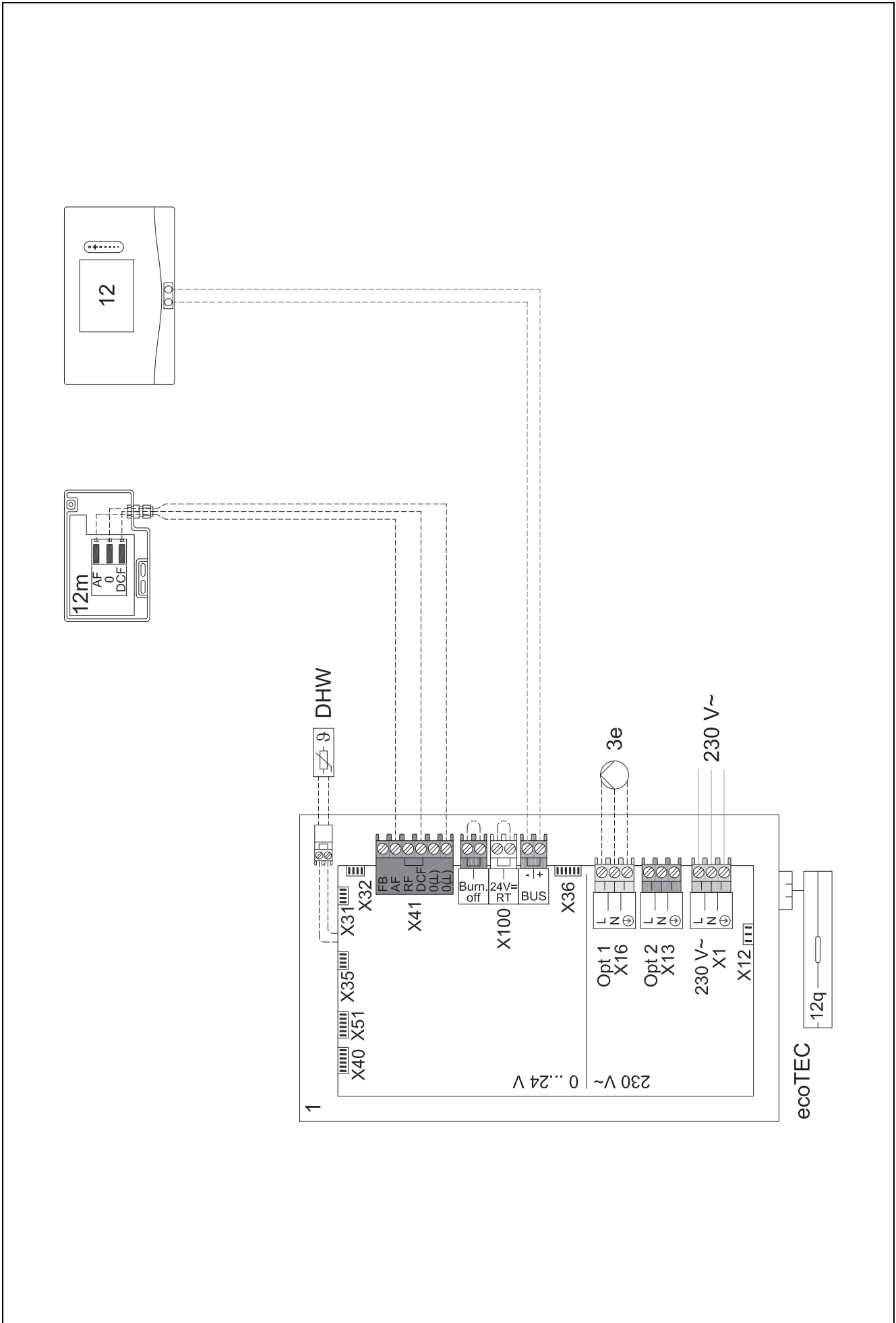

### **4.9.3 Basic system diagram 0020178440**

#### **4.9.3.1 Setting on the system control**

**Basic system diagram code: 1**

**FM3 configuration: 1**

**FM3 MO: Circulation pump**

**Circuit 1 / Circuit type: Heating**

**Circuit 2 / Circuit type: Heating**

**Zone 1/ Zone activated: Yes**

**Zone 2/ Zone activated: Yes**

4.9.3.2 Basic system diagram 0020178440

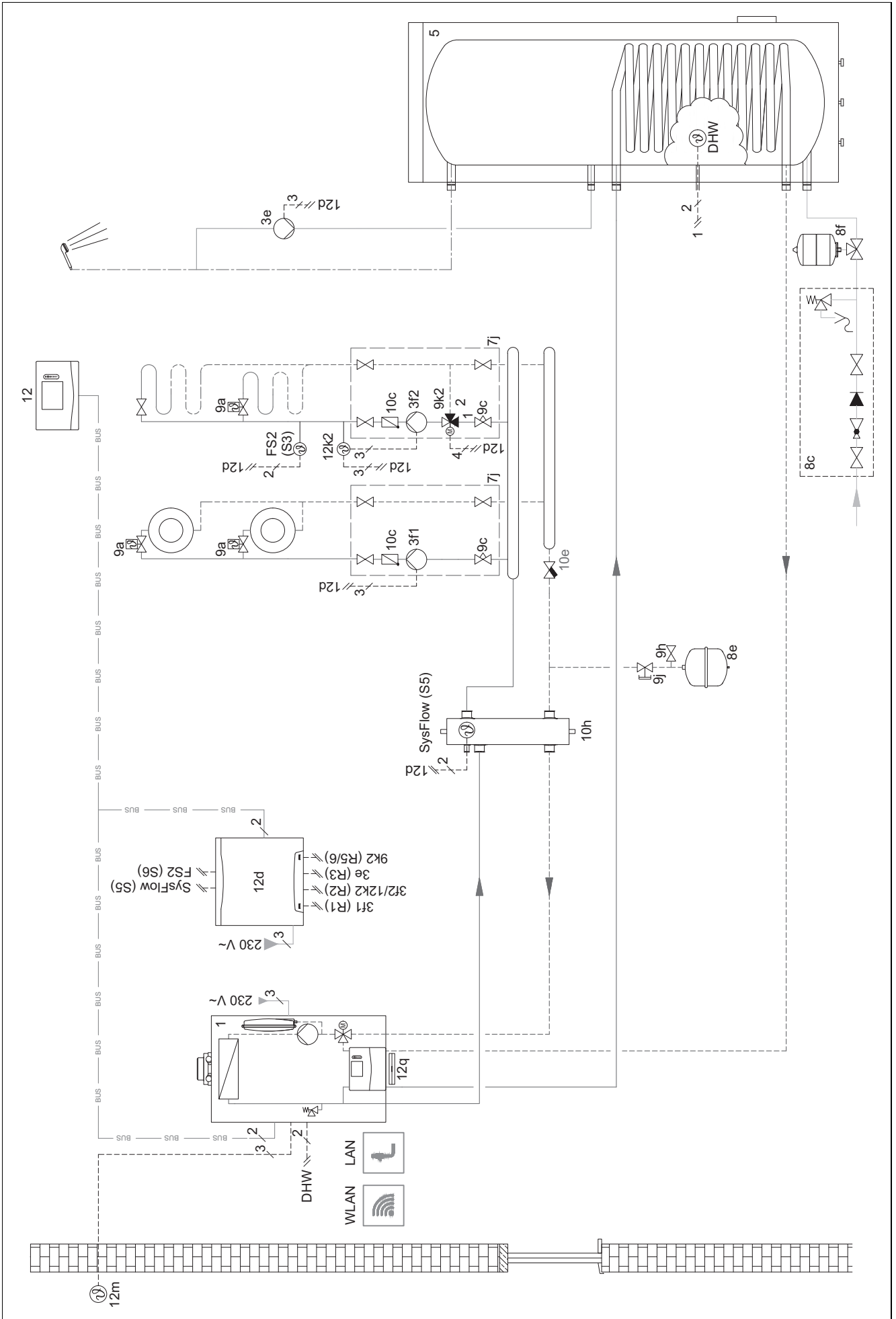



### 4.9.3.3 Wiring diagram 0020178440

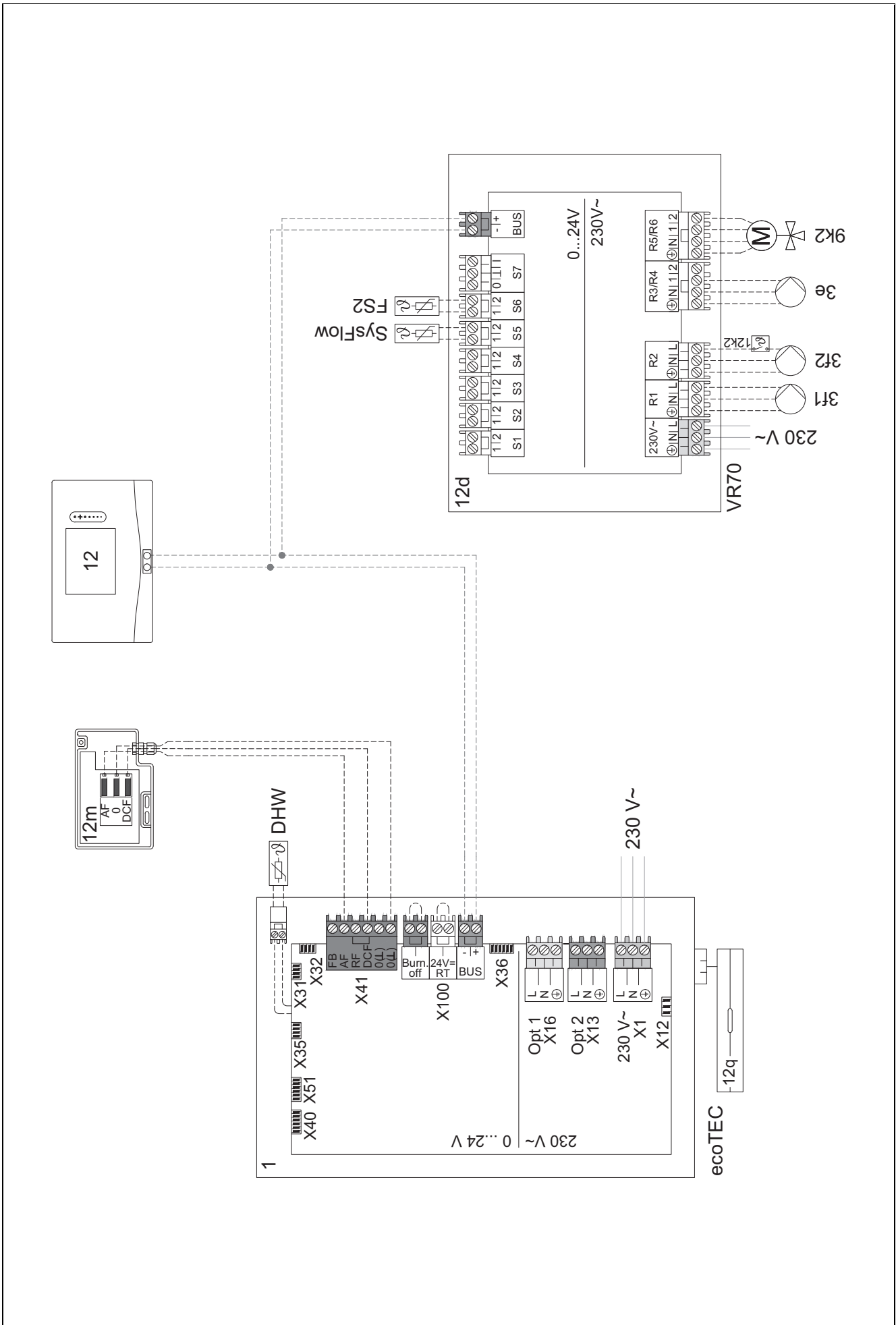

#### **4.9.4 Basic system diagram 0020177912**

##### **4.9.4.1 Special features of the system**



8: At least 35% of the nominal flow rate must always be able to flow through a reference room without an individual room temperature control valve.

##### **4.9.4.2 Settings on the system control**

**Basic system diagram code:** 8

**Circuit 1 / Room temp. mod.:** Active or Expanded

**Zone 1 / Zone assignment:** Sys. control

##### **4.9.4.3 Settings in the heat pump**

Cooling technology: No cooling

#### 4.9.4.4 Basic system diagram 0020177912

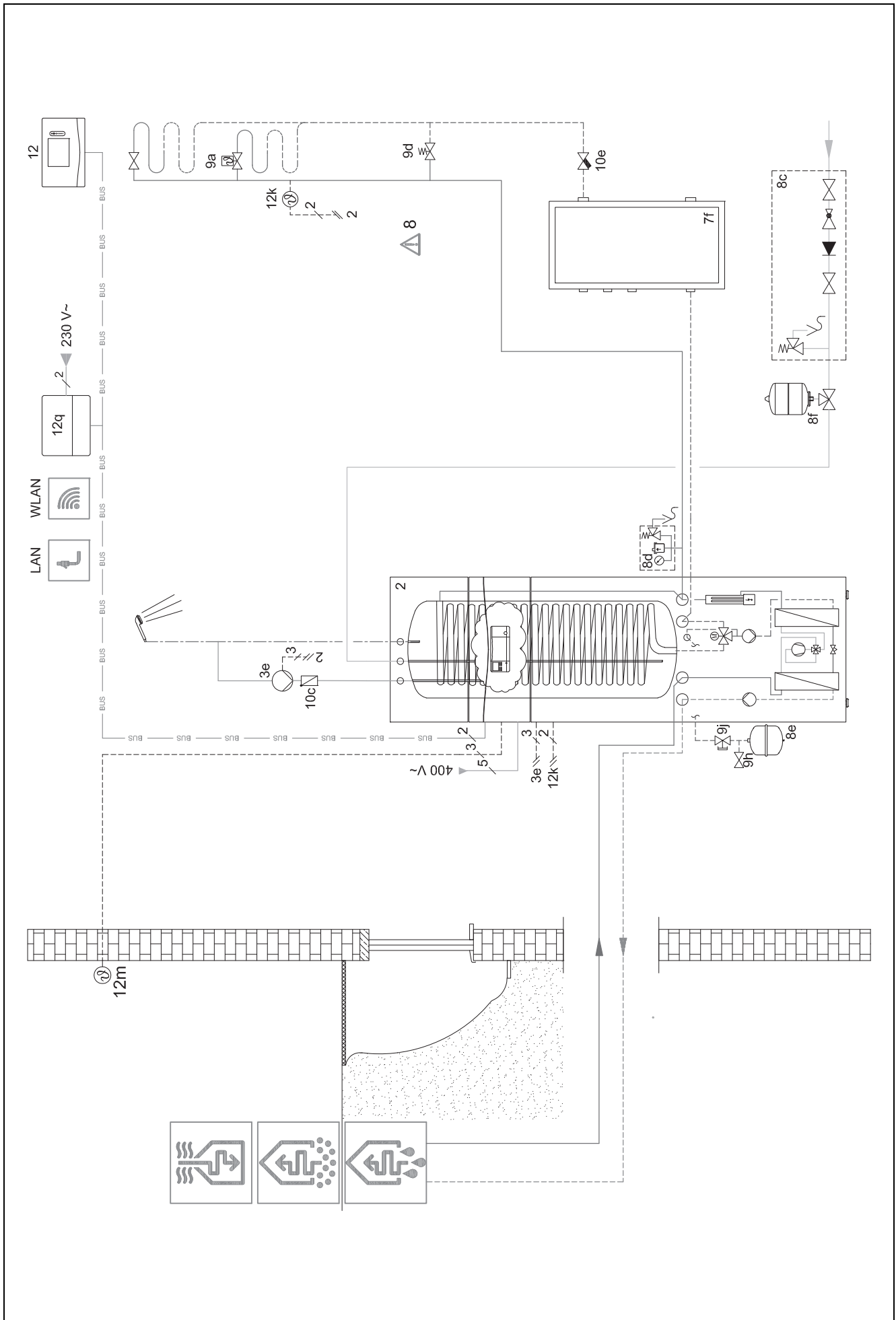



## **4.9.5 Basic system diagram 0020280010**

### **4.9.5.1 Special features of the system**



5: The cylinder temperature cut-out must be installed in a suitable location in order to avoid cylinder temperatures above 100 °C.

### **4.9.5.2 Settings on the system control**

**Basic system diagram code: 1**

**FM5 configuration: 2**

**FM5 MO: Anti-legio. pump**

**Circuit 1 / Circuit type: Heating**

**Circuit 1 / Room temp. mod.: Active or Expanded**

**Circuit 2 / Circuit type: Heating**

**Circuit 2 / Room temp. mod.: Active or Expanded**

**Circuit 3 / Circuit type: Heating**

**Circuit 3 / Room temp. mod.: Active or Expanded**

**Zone 1 / Zone activated: Yes**

**Zone 1 / Zone assignment: Rem. contr. 1**

**Zone 2 / Zone activated: Yes**

**Zone 2 / Zone assignment: Rem. contr. 2**

**Zone 3 / Zone activated: Yes**

**Zone 3 / Zone assignment: Sys. control**

### **4.9.5.3 Settings at the remote control**

**Remote control address: (1): 1**

**Remote control address: (2): 2**

### 4.9.5.4 Basic system diagram 0020280010

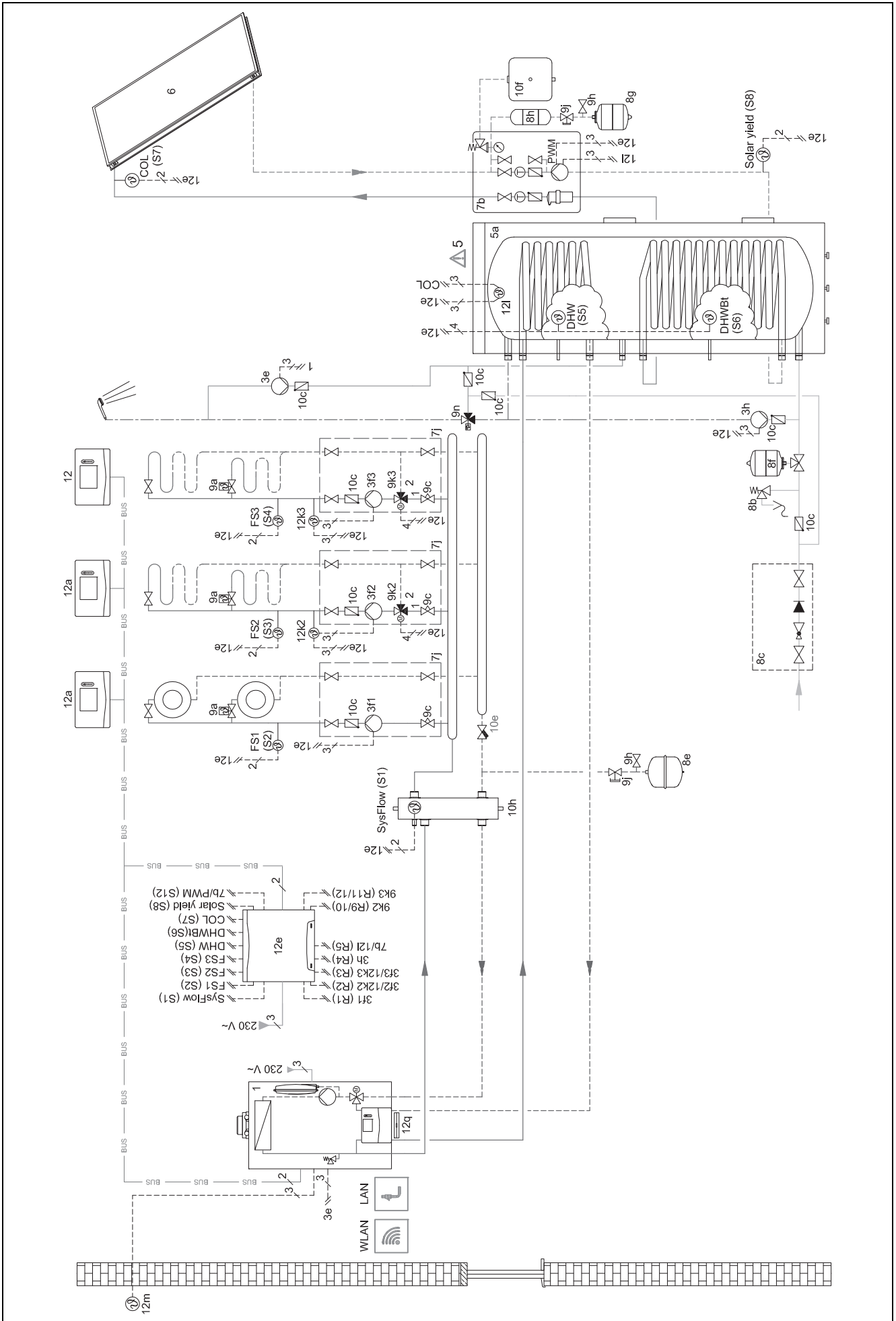

### 4.9.5.5 Wiring diagram 0020280010

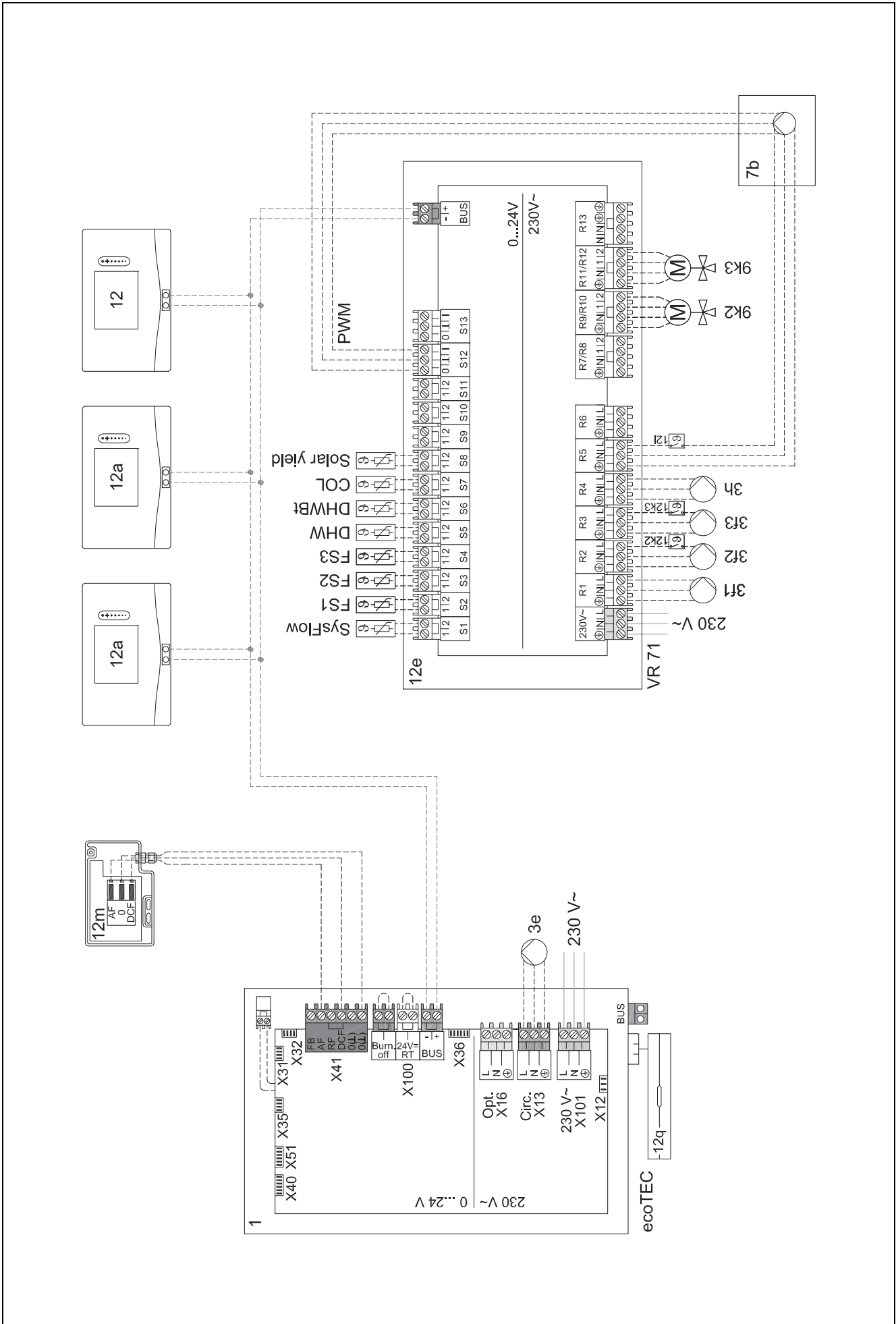

## **4.9.6 Basic system diagram 0020260774**

### **4.9.6.1 Special features of the system**



17: Optional component

### **4.9.6.2 Setting on the system control**

**Basic system diagram code: 1**

**FM5 configuration: 6**

**Circuit 1 / Circuit type: Heating**

**Circuit 1 / Room temp. mod.: Active or Expanded**

**Circuit 2 / Circuit type: Heating**

**Circuit 2 / Room temp. mod.: Active or Expanded**

**Circuit 3 / Circuit type: Heating**

**Circuit 3 / Room temp. mod.: Active or Expanded**

**Zone 1/ Zone activated: Yes**

**Zone 1 / Zone assignment: Rem. contr. 1**

**Zone 2/ Zone activated: Yes**

**Zone 2 / Zone assignment: Rem. contr. 2**

**Zone 3/ Zone activated: Yes**

**Zone 3 / Zone assignment: Sys. control**

### **4.9.6.3 Settings at the remote control**

**Remote control address: (1): 1**

**Remote control address: (2): 2**



#### 4.9.6.4 Basic system diagram 0020260774

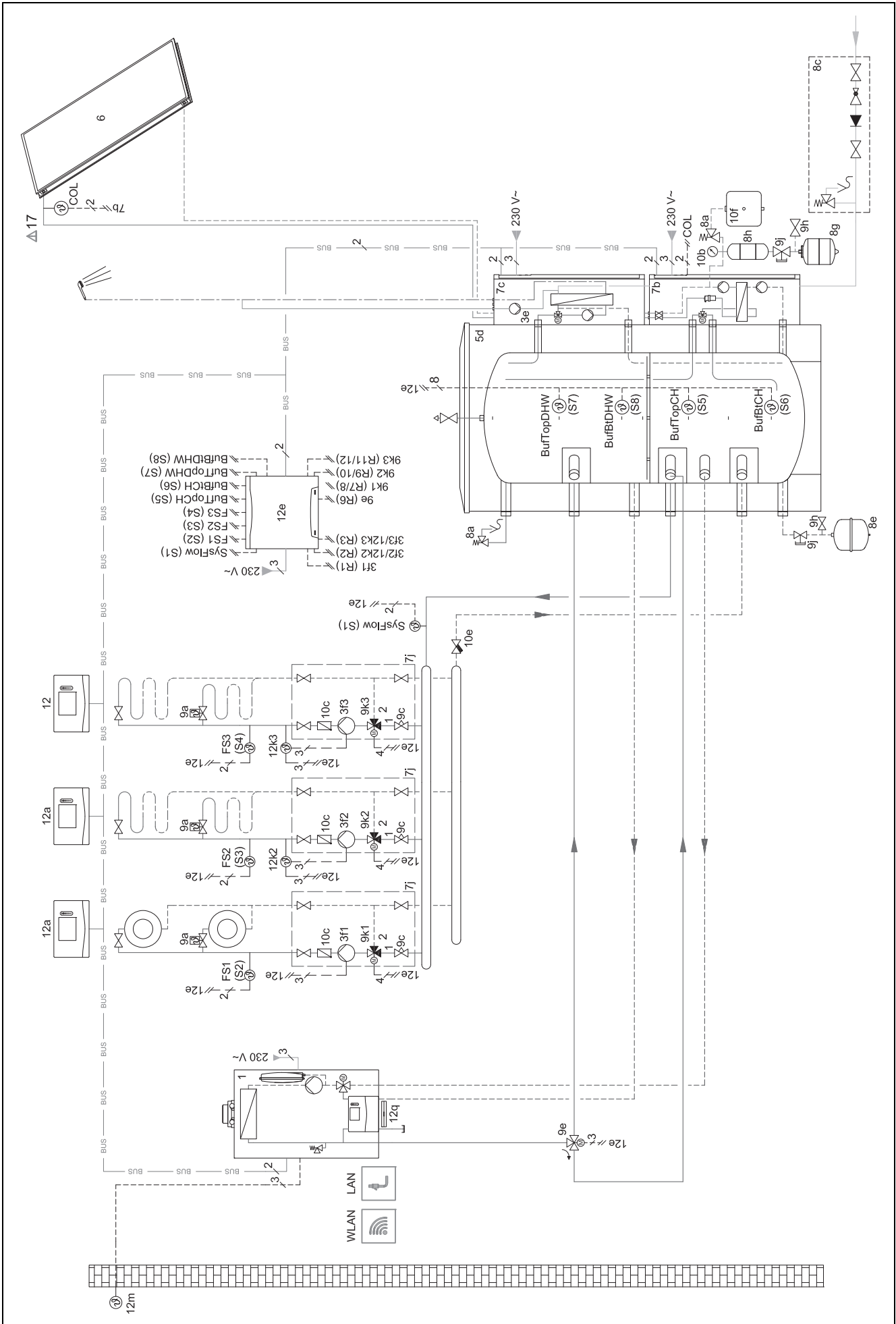

4.9.6.5 Wiring diagram 0020260774

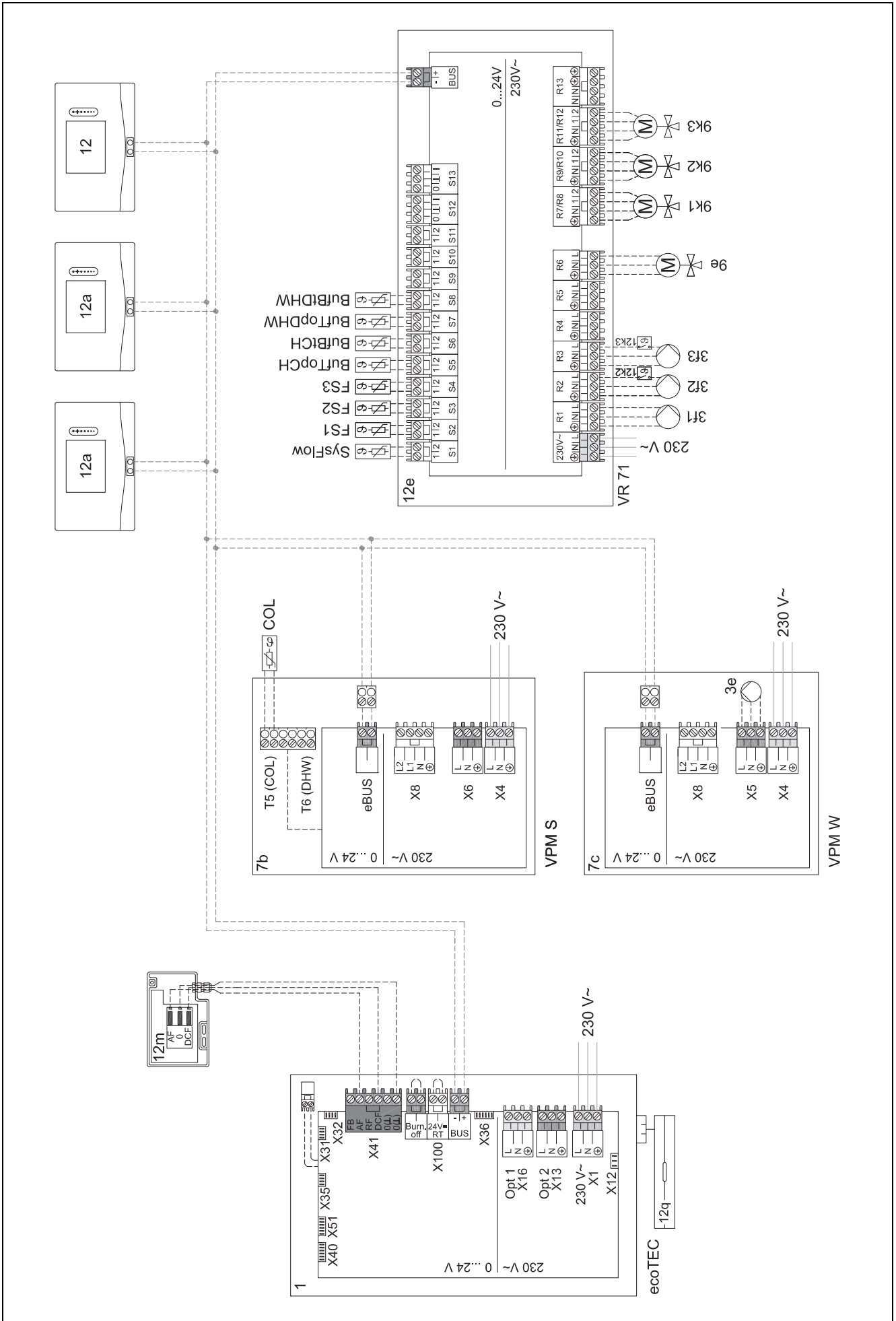

## 5 -- Start-up

### 5.1 Prerequisites for starting up

- The system control and outdoor temperature sensor have been installed and wired.
- The FM5 functional module is installed and connected in accordance with configuration 1, 2, 3 or 6, see supplement.
- The FM3 functional modules are installed and connected, see supplement. A unique address is assigned to each FM3 functional module via the address switch.
- Start-up of all system components (except for the system control) is complete.

### 5.2 Running the installation assistants

The installation assistant is at the **Language:** query.

The system control's installation assistant takes you through a list of functions. For each function, you should choose the set value that is best suited to the heating installation being installed.

#### 5.2.1 Completing the installation assistant

Once you have gone through the installation assistant, **Select the next step.** appears on the display

**Installation configuration:** The installation assistant switches to the system configuration for the installer level, in which you can further optimise the heating installation.

**Installation start:** The installation assistant switches to the basic display and the heating installation works with the values you have set.

**Sensor/actuator test:** The installation assistant switches to the sensor/actuator test function. You can test the sensors and actuators here.

### 5.3 Changing the settings later

All settings that you have made via the installation assistant can be changed again at a later date via the end user or installer level.

### 5.4 Retroactively setting cooling mode

#### Preliminary work

1. Check whether your heat pump is equipped with the cooling mode function.



#### Note

Cooling mode is product-dependent. If the cooling mode function is not available for the heat pump, an optional accessory must be installed.

2.

**Condition:** Heat pump with cooling mode function

- 2.1. Activate cooling mode on the heat pump's control panel (for cascades of all cooling heat pumps) (→ Installation instructions for the heat pump).
- 2.2. Briefly switch off the heat pump (in cascades, heat pump 1) and, if required, FM5.
- 2.3. Switch the heat pump (in cascades, heat pump 1) and, if required, FM5 back on.
  - ◁ The system control is informed that the heat pump's cooling mode is activated.

1. In the system control, navigate to the **MENU | SETTINGS | Installer level | Installation configuration | Circuit | Cooling possible:** function and confirm by pressing **Yes**.
2. Navigate to the **MENU | SETTINGS | Installer level | Installation configuration | Circuit | Min. cooling targ. flow temp.: °C** function and set the temperature.



#### Note

If the target flow temperature is set too low, condensate may form.

3. If required, navigate to the **MENU | SETTINGS | Installer level | Installation configuration | Circuit | Room temp. mod.:** function and select **Active** or **Expanded**.
4. If required, navigate to the **MENU | SETTINGS | Installer level | Installation configuration | Circuit | Dew point monitoring:** function and confirm by pressing **Yes**.
5. If required, navigate to the **MENU | SETTINGS | Installer level | Installation configuration | Installation | Automatic cooling:** function and select **Activated**.

## 6 Fault and maintenance messages

### 6.1 Fault

#### How to respond if the heat pump fails

The system control switches to limp home mode, i.e. the back-up boiler supplies the heating installation with heating energy. During installation, the competent person has restricted the temperature for limp home mode. You can feel that the domestic hot water and heating are not becoming very hot.

You can select one of the following settings until the competent person arrives:

**Off:** The heating and domestic hot water only become moderately hot.

**Heating:** The back-up boiler takes over the heating mode; the heating becomes hot and the domestic hot water is cold.

**DHW:** The back-up boiler takes over the domestic hot water mode; the domestic hot water becomes hot and the heating is cold.

**DHW + heat.:** The back-up boiler takes over the heating and domestic hot water mode; the heating and domestic hot water become hot.

The back-up boiler is not as efficient as the heat pump, meaning that using only the back-up boiler to generate heat is expensive.

Troubleshooting (→ Appendix A.1)

## 6.2 Fault message



with the text of the fault message appears in the display.

You can find fault messages under **MENU | SETTINGS | Installer level | Fault history**



Troubleshooting (→ Appendix B.2)

## 6.3 Maintenance message



with the text of the maintenance message appears in the display.

Maintenance message (→ Appendix)

# 7 Information about the product

## 7.1 Observing and storing other applicable documents

- ▶ Observe all of the instructions that are intended for you and are enclosed with the components of the installation.
- ▶ As the end user, keep these instructions and all other applicable documents safe for future use.

## 7.2 Validity of the instructions

**Validity:** People's Republic of China OR Moldova OR Ukraine

These instructions apply only to:

- 0010045479

## 7.3 Data plate

The data plate is located on the rear of the product.

Information on the data plate	Meaning
Serial number	for identification; 7th to 16th digits = product article number
sensoCOMFORT	Product designation
V	Rated voltage
mA	Rated current
	Read the instructions

## 7.4 Serial number

You can call up the serial numbers under **MENU | INFORMATION | Serial number**. The 10-digit article number is located in the second line.

## 7.5 CE marking



The CE marking shows that the products comply with the basic requirements of the applicable directives as stated on the declaration of conformity.

The declaration of conformity can be viewed at the manufacturer's site.

## 7.6 Guarantee and customer service

### 7.6.1 Guarantee

You can find information about the manufacturer's guarantee in the Country specifics.

### 7.6.2 Customer service

The contact details for our customer service are provided on the back page or on our website.

## 7.7 Recycling and disposal

This product is an electrical or electronic unit within the context of EU Directive 2012/19/EU. The unit was developed and manufactured using high-quality materials and components. These can be recycled and reused.

Find out about the regulations that apply in your country regarding the separate collection of waste electrical or electronic equipment. Correctly disposing of old units protects the environment and people against potential negative effects.

### Disposing of the packaging

- ▶ Dispose of the packaging correctly.
- ▶ Observe all relevant regulations.

### Disposing of the product

- ▶ Dispose of the product and its accessories correctly.
- ▶ Observe all relevant regulations.



■ If the product is labelled with this symbol:

- ▶ In this case, do not dispose of the product with the household waste.
- ▶ Instead, hand in the product to a collection centre for waste electrical or electronic equipment.

### Deleting personal data

Personal data (e.g. online login details) may be misused by unauthorised third parties.

If the product contains personal data:

- ▶ Ensure that there is no personal data on or in the product before you dispose of the product.

## 7.8 Product data in accordance with EU Ordinance no. 811/2013, 812/2013

On units with integrated weather-compensated controls, including a room thermostat function that can be activated, the seasonal room-heating efficiency always includes the correction factor for control technology class VI. The seasonal room-heating efficiency may deviate if this function is deactivated.

Temperature control class	VI
Contribution to the seasonal room-heating energy efficiency $\eta_s$	4.0 %







## 7.9 Technical data – System control

Rated voltage	9 to 24 V $\overline{---}$
Rated surge voltage	330 V
Pollution degree	2
Rated current	< 50 mA
Supply line cross-section	0.75 to 1.5 mm <sup>2</sup>
IP rating	IP 20
Protection class	III
Temperature for the ball pressure test	75 °C
Maximum permitted environmental temperature	0 to 60 °C
Current room air hum.	35 to 95 %
Mode of operation	Type 1
Height	109 mm
Width	175 mm
Depth	26 mm

## Appendix

### A Troubleshooting, maintenance message

#### A.1 Troubleshooting

Symptom	Possible cause	Measure
Display remains dark	Software error	<ol style="list-style-type: none"> <li>Press and hold the button on the top right of the system control for longer than five seconds in order to force a re-start.</li> <li>Switch off the mains switch on all heat generators for approx. 1 minute and then switch them on again.</li> <li>If the fault message persists, inform the competent person.</li> </ol>
No changes in the display can be made via the control elements	Software error	<ol style="list-style-type: none"> <li>Press and hold the button on the top right of the system control for longer than five seconds in order to force a re-start.</li> <li>Switch off the mains switch on all heat generators for approx. 1 minute and then switch them on again.</li> <li>If the fault message persists, inform the competent person.</li> </ol>
Display: <b>Button lock activated</b> , it is not possible to change the settings or values	Button lock is active	▶ Press the button on the top right of the system control for approx one second in order to deactivate the button lock.
Display: <b>Mode: Back-up heater if fault occurs Heat pump (call the comp. person)</b> , insufficient heating-up of the heating and the domestic hot water	Heat pump does not work	<ol style="list-style-type: none"> <li>Inform the competent person.</li> <li>Select the setting for limp home mode until the competent person arrives.</li> <li>You can find more detailed explanations under Faults, fault messages and maintenance messages (→ Section 6).</li> </ol>
Display: <b>F. Boiler fault</b> , the specific fault code (e.g. F.33) with the specific boiler is shown in the display	Boiler fault	<ol style="list-style-type: none"> <li>Reset the boiler by first selecting <b>Reset</b> and then <b>Yes</b>.</li> <li>If the fault message persists, inform the competent person.</li> </ol>
Display: You do not understand the set language	Incorrect language set	<ol style="list-style-type: none"> <li>Press  twice.</li> <li>Select the last menu item ( <b>SETTINGS</b>) and confirm by pressing .</li> <li>Under  <b>SETTINGS</b>, select the second menu item and confirm by pressing .</li> <li>Select the language that you understand and confirm by pressing .</li> </ol>

#### A.2 Maintenance messages

#	Code/meaning	Description	Maintenance work	Interval	
1	<b>Water deficiency: Follow the instructions in the heat gen.</b>	The water pressure is too low in the heating installation.	Refer to the operating instructions for the relevant heat generator for information on filling with water	See the operating instructions for the heat generator	

## B -- Troubleshooting, maintenance message

#### B.1 Troubleshooting

Symptom	Possible cause	Measure
Display remains dark	Software error	<ol style="list-style-type: none"> <li>Press and hold the button on the top right of the system control for longer than five seconds in order to force a re-start.</li> <li>Switch the mains switch on the heat generator that feeds the system control off and back on again.</li> </ol>
	No power supply on the heat generator	▶ Re-establish the power supply to the heat generator; this is the same power supply that feeds the control.
	The product is defective	▶ Replace the product.
No changes in the display can be made via the control elements	Software error	▶ Switch the mains switch on the heat generator that feeds the control off and back on again.
	The product is defective	▶ Replace the product.

Symptom	Possible cause	Measure
Heat generator continues to heat once the room temperature has been reached	Incorrect value in the <b>Room temp. mod.:</b> or <b>Zone assignment:</b> function	<ol style="list-style-type: none"> <li>In the <b>Room temp. mod.:</b> function, set the value <b>Active</b> or <b>Expanded</b>.</li> <li>In the zone in which the system control is installed, assign the system control's address in the <b>Zone assignment:</b> function.</li> </ol>
The heating installation remains in domestic hot water mode	Heat generator cannot reach the max. target flow temperature	▶ Reduce the set value in the <b>Max. target flow temperature:°C</b> function.
Only one of several heating circuits is displayed	Heating circuits inactive	▶ In the <b>Circuit type:</b> function, define the required function for the heating circuit.
It is not possible to switch to the installer level	You do not know the code for the installer level	▶ Reset the system control to the factory setting. All set values will be lost.

## B.2 Troubleshooting

Code/meaning	Possible cause	Measure
<b>Ventilation unit communication interrupted</b> F.509	The cable is defective	▶ Replace the cable.
	Incorrect plug connection	▶ Check the plug connection.
<b>HP control module communication interrupted</b> F.511	The cable is defective	▶ Replace the cable.
	Incorrect plug connection	▶ Check the plug connection.
<b>Heat generator 1 communication interrupted</b> (can be heat generator 1 to 8) F.1191...F.1195, F.1200...F.1211, F.1252...F.1255	The cable is defective	▶ Replace the cable.
	Incorrect plug connection	▶ Check the plug connection.
<b>FM3 address 1 communication interrupted</b> (can be address 1 to 3) F.1212...F.1214	The cable is defective	▶ Replace the cable.
	Incorrect plug connection	▶ Check the plug connection.
<b>FM5 communication interrupted</b> F.1218	The cable is defective	▶ Replace the cable.
	Incorrect plug connection	▶ Check the plug connection.
<b>Remote control 1 communication interrupted</b> (can be address 1 to 3) F.1219...F.1222	The cable is defective	▶ Replace the cable.
	Incorrect plug connection	▶ Check the plug connection.
<b>Domestic hot water station communication interrupted</b> F.1227	The cable is defective	▶ Replace the cable.
	Incorrect plug connection	▶ Check the plug connection.
<b>Solar pump station communication interrupted</b> F.1228, F.1229	The cable is defective	▶ Replace the cable.
	Incorrect plug connection	▶ Check the plug connection.
<b>Internet module communication interrupted</b> F.900	The cable is defective	▶ Replace the cable.
	Incorrect plug connection	▶ Check the plug connection.
<b>Outdoor temperature sensor signal invalid</b> F.521	Outdoor temperature sensor defective	▶ Replace the outdoor temperature sensor.
<b>FM3 configuration [1] not correct</b> (can be address 1 to 3) F.1231...F.1233	Incorrect set value for the FM3	▶ Set the correct set value for the FM3.
<b>Mixer module not supported</b> F.1237	Unsuitable module connected	▶ Install a module that the control supports.
<b>Solar module not supported</b> F.1238	Unsuitable module connected	▶ Install a module that the control supports.
<b>Remote control not supported</b> F.1239	Unsuitable module connected	▶ Install a module that the control supports.
<b>Basic system diagram code not correct</b> F.1240	Incorrectly selected basic system diagram code	▶ Set the correct basic system diagram code.

Code/meaning	Possible cause	Measure
<b>FM3 missing</b> F.1244	Missing FM3	▶ Connect the FM3.
<b>DHW temperature sensor S1 missing at FM3</b> F.1245	Domestic hot water temperature sensor S1 not connected	▶ Connect the domestic hot water temperature sensor to the FM3.
<b>Solar pump 1 reports faults</b> (can be solar pump 1 or 2) F.1246, F.1247	Fault in the solar pump	▶ Check the solar pump.
<b>Shift-load cylinder not supported</b> F.1248	Unsuitable cylinder connected	▶ Remove the cylinder from the heating installation.
<b>HP control module MO2 configuration not correct</b> F.1249	Incorrectly connected FM3	1. Remove the FM3. 2. Select a suitable configuration.
	Incorrectly connected FM5	1. Remove the FM5. 2. Select another configuration.
<b>FM5 configuration not correct</b> F.1251	Incorrect set value for the FM5	▶ Set the correct set value for the FM5.
<b>FM3 configuration [1] MO not correct</b> (can be address 1 to 3) F.1257...F.1259	Incorrect component selection for the MO	▶ Select the component in the <b>FM3 MO</b> function that is appropriate for the connected component on the FM3's multi-function output.
<b>FM5 configuration MO not correct</b> F.1263	Incorrect component selection for the MO	▶ Select the component in the <b>FM5 MO</b> function that is appropriate for the connected component on the FM5's multi-function output.
<b>Sys. control room temperature sensor signal invalid</b> F.1361	Room temperature sensor defective	▶ Replace the control.
<b>Room temp. sensor signal on remote control 1 invalid</b> (can be address 1 to 3) F.1363...F.1366	Room temperature sensor defective	▶ Replace the remote control.
<b>S1 sensor signal at FM3 address 1 invalid</b> (can be S1 to 7 and address 1 to 3) F.5000...F.5020	Sensor defective	▶ Replace the sensor.
<b>S1 sensor signal at FM5 invalid</b> (can be S1 to S13) F.5021...F.5033	Sensor defective	▶ Replace the sensor.
<b>Heat generator 1 reports faults</b> (can be heat generator 1 to 8) F.5034...F.5049	Fault in the heat generator	▶ See the instructions for the heat generator displayed.
<b>Ventilation unit reports faults</b> F.5050	Ventilation unit fault	▶ See instructions for the ventilation unit.
<b>HP control module reports faults</b> F.5051	Fault in the heat pump control module	▶ Replace the heat pump control module.
<b>Assignment of remote control 1 missing</b> (can be address 1 to 3) F.5056...F.5059	The assignment of remote control 1 to the zone is missing.	▶ Assign the correct address to the remote control in the <b>Zone assignment:</b> function.
<b>Zone activation missing</b> F.5060	A zone that is in use is not yet activated.	▶ In the <b>Zone activated:</b> function, select the value <b>Yes</b> .
	Heating circuits inactive	▶ In the <b>Circuit type:</b> function, define the required function for the heating circuit.



### B.3 Maintenance messages

#	Code/meaning	Description	Maintenance work	Interval	
1	<b>Heat generator 1 requires maintenance</b> *, * Can be heat generator 1 to 8	The heat generator requires maintenance work.	Refer to the operating or installation instructions for the relevant heat generator for information on the maintenance work required	See the operating or installation instructions for the heat generator	
2	<b>Ventilation unit requires maintenance</b>	The ventilation unit requires maintenance work.	Refer to the operating or installation instructions for the relevant ventilation unit for information on the maintenance work required	See the operating or installation instructions for the ventilation unit	
3	<b>Water deficiency: Follow the instructions in the heat gen.</b>	The water pressure is too low in the heating installation.	Water deficiency: Follow the instructions in the heat generator	See the operating or installation instructions for the heat generator	
4	<b>Maintenance Contact:</b>	Date on which maintenance is due for the heating installation.	Carry out the required maintenance work	Date entered in the control	

# Index

<b>A</b>	
Article number .....	52
<b>C</b>	
CE marking.....	52
Connecting a system control to the heat generator .....	23
Connecting a system control to the ventilation unit.....	23
Connecting the system control.....	23
Control elements .....	8
<b>D</b>	
Determining the installation site .....	23
Display.....	8
Disposal.....	52
Documents .....	52
<b>F</b>	
Fault .....	51
Faults.....	51
Frost .....	5
<b>I</b>	
Intended use.....	4
<b>M</b>	
Maintenance.....	51
<b>P</b>	
Prerequisites for starting up the heating installation .....	51
Prerequisites, start-up .....	51
Preventing a malfunction.....	7
<b>Q</b>	
Qualification.....	4
<b>R</b>	
Reading the article number .....	52
Reading the serial number .....	52
Recycling .....	52
Regulations .....	5
Running the installation assistants .....	51
<b>S</b>	
Serial number .....	52
Setting the heat curve .....	8

# Country specifics

## 1 CN, China

### 1.1 China Energy Label (中国能效标识)

China Energy Label (中国能效标识) 显示，设备满足相应的能效等级。

### 1.2 保修

在威能公司及其指定代理商的技术人员进行安装的情况下，我们对产品提供保修服务。

我们根据具体情况为用户提供1年的保修服务。保修服务只能由威能售后服务部来提供。

### 1.3 客户服务

威能售后服务电话: 400 7001890

传真: 021 60287999

## 2 MD, Moldova

### 2.1 Garanția

Puteți solicita informații privind garanția producătorului la adresa de contact indicată pe partea posterioară.

### 2.2 Serviciul de asistență tehnică

Datele de contact pentru serviciul nostru de asistență tehnică le găsiți la adresa indicată pe partea posterioară sau pe [www.vaillant.com](http://www.vaillant.com).

## 3 UA, Ukraine

### 3.1 Країна виготовлення

Країна-виробник	Виготовлено у Франції
-----------------	-----------------------

### 3.2 Назва виробу

Виріб - це погодозалежний регулятор.

### 3.3 Національний знак відповідності України



Маркування національним знаком відповідності виробу свідчить його відповідність вимогам Технічних регламентів України.

## 3.4 Правила упаковки, транспортування і зберігання

Вироби поставляються в упаковці підприємства-виробника.

Вироби транспортуються автомобільним, водним і залізничним транспортом відповідно до правил перевезення вантажів, що діють на конкретному виді транспорту. При транспортуванні необхідно передбачити надійне закріплення виробів від горизонтальних і вертикальних переміщень.

Невстановлені вироби зберігаються в упаковці підприємства-виробника. Зберігати вироби необхідно в закритих приміщеннях з природною циркуляцією повітря в стандартних умовах (неагресивне середовище без пилу, температура зберігання від -10 °C до +37 °C, вологість повітря до 80 %, без ударів і вібрацій).

## 3.5 Термін зберігання

– Термін зберігання: 22 місяці з дати виробництва

## 3.6 Термін служби

За умов дотримання приписів щодо транспортування, зберігання, монтажу і експлуатації, очікуваний термін служби виробу складає 15 років зі дня встановлення.

## 3.7 Дата виготовлення

Дата виготовлення (тиждень, рік) вказані в серійному номері на паспортній табличці:

- третій і четвертий знак серійного номера вказують рік виробництва (у двозначному форматі).
- п'ятий і шостий знак серійного номера вказують тиждень виробництва (від 01 до 52).

## 3.8 Гарантія заводу-виробника для України

1. Гарантія надається на наведені в інструкції для кожного конкретного приладу технічні характеристики.
2. Термін гарантії заводу виробника:
  - 12 місяців від дня введення устаткування в експлуатацію, але не більше 18 місяців від дня покупки товару;
  - за умови підписання сервісного договору між користувачем та сервіс-партнером по закінченню першого року гарантії
  - 24 місяця від дня введення устаткування в експлуатацію, але не більш 30 місяців від дня покупки товару; при обов'язковому дотриманні наступних умов
    - а) устаткування придбане у офіційних поставальників Vaillant у країні, де буде здійснюватися його установка;
    - б) введення в експлуатацію і обслуговування устаткування здійснюється уповноваженими Vaillant організаціями, що мають чинні місцеві дозволи і ліцензії (охорона праці, газова служба, пожежна безпека і т.д.);
    - в) були дотримані всі приписи, наведені в технічній документації Vaillant для конкретного приладу.
3. Виконання гарантійних зобов'язань, передбачених чинним законодавством тої місцевості, де був придбаний апарат виробництва фірми Vaillant, здійснюють сервісні організації, уповноважені Vaillant, або

фірмовий сервіс Vaillant, що мають чинні місцеві дозволи і ліцензії (охорона праці, газова служба, пожежна безпека і т.д.).

4. Гарантійний термін на замінені після закінчення гарантійного строку вузли, агрегати і запасні частини становить 6 місяців. У результаті ремонту або заміни вузлів і агрегатів гарантійний термін на виріб у цілому не поновлюється.
5. Гарантійні вимоги задовольняються шляхом ремонту або заміни виробу за рішенням уповноваженої Vaillant організації.
6. Вузли і агрегати, які були замінені на справні, є власністю Vaillant і передаються уповноваженій організації.
7. Обов'язковим є застосування оригінальних приладь (труби для підведення повітря і/або відводу продуктів згоряння, регулятори, і т.д.), запасних частин;
8. Претензії щодо виконання гарантійних зобов'язань не приймаються, якщо:
  - а) зроблені самостійно, або не уповноваженими особами, зміни в устаткуванні, підключенні газу, притоку повітря, води й електроенергії, вентиляції, на димоходах, будівельні зміни в зоні встановлення устаткування;
  - б) устаткування було ушкоджено при транспортуванні або неналежному зберіганні;
  - в) при недотриманні інструкцій з правил монтажу, і експлуатації устаткування;
  - г) робота здійснюється при тиску води понад 10 бар (для водонагрівачів);
  - д) параметри напруги електромережі не відповідають місцевим нормам;
  - е) збиток викликаний недотриманням державних технічних стандартів і норм;
  - ж) збиток викликаний потраплянням сторонніх предметів в елементи устаткування;
  - з) застосовується неоригінальне приладдя і/або запасні частини.
9. Уповноважені організації здійснюють безоплатний ремонт, якщо недоліки не викликані причинами, зазначеними в пункті 7 (8), і роблять відповідні записи в гарантійному талоні.

### **3.9 Обслуговування клієнтів**

Безкоштовна інформаційна телефонна лінія по Україні

Гаряча лінія: 0800 501 805







## Supplier

### 威能（中国）供热制冷环境技术有限公司

12-15层 上海市黄浦区鲁班路558号经纬国际大厦 ■ 中国上海 200023

电话 021 60287900 ■ 传真 021 60287999

威能售后服务电话 400 7001890

info@vaillant.com.cn ■ www.vaillant.cn

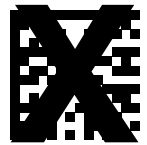

0020334316\_03

### Vaillant Group International GmbH

Berghauser Strasse 40 ■ D-42859 Remscheid

Tel. +49 2191 18 0

www.vaillant.com

### ДП «Вайллант Група Україна»

вул. Лаврська 16 ■ 01015 м. Київ

Тел. 044 339 9840 ■ Факс. 044 339 9842

Гаряча лінія 0800 501 805

info@vaillant.ua ■ www.vaillant.ua



### Publisher/manufacturer

#### Vaillant GmbH

Berghauser Str. 40 ■ D-42859 Remscheid

Tel. +49 2191 18 0 ■ Fax +49 2191 18 2810

info@vaillant.de ■ www.vaillant.de

#### 威能有限责任公司

40号贝尔豪森大街 ■ 雷姆沙伊德 区号 42859

Tel. +492191 18 0 ■ Fax +492191 18 2810

info@vaillant.de ■ www.vaillant.de

© These instructions, or parts thereof, are protected by copyright and may be reproduced or distributed only with the manufacturer's written consent. Subject to technical modifications.